

# SDS2000X Plus Series

## Digital Oscilloscope

### Service Manual

SM0102XP-E01A



# Contents

<b>CONTENTS</b> .....	<b>2</b>
<b>1 GENERAL SAFETY SUMMARY</b> .....	<b>4</b>
1.1 SAFETY TERMS AND SYMBOLS .....	4
1.2 WORKING ENVIRONMENT .....	5
1.3 COOLING REQUIREMENTS .....	6
1.4 AC POWER .....	7
1.5 POWER AND GROUND CONNECTIONS .....	8
1.6 CALIBRATION .....	9
1.7 CLEANING .....	9
1.8 ABNORMAL CONDITIONS .....	9
<b>2 FIRST STEPS</b> .....	<b>11</b>
2.1 DELIVERY CHECKLIST .....	11
2.2 QUALITY ASSURANCE .....	11
2.3 MAINTENANCE AGREEMENT .....	12
<b>3 DOCUMENT CONVENTIONS</b> .....	<b>13</b>
<b>4 PREPARE INFORMATION</b> .....	<b>14</b>
4.1 FUNCTIONAL CHECKS .....	14
4.1.1 <i>Power-on Inspection</i> .....	14
4.1.2 <i>Probe Compensation</i> .....	16
4.1.3 <i>Auto Setup</i> .....	17
4.1.4 <i>Self-Calibration</i> .....	18
4.2 INTERFACE TEST .....	19
4.2.1 <i>USB Host Test</i> .....	19
4.2.2 <i>USB Device Test</i> .....	20
4.2.3 <i>LAN Port Test</i> .....	22
4.2.4 <i>Pass/Fail out Test</i> .....	24
<b>5 PERFORMANCE TEST</b> .....	<b>27</b>
5.1 TO VERIFY DC GAIN ACCURACY .....	31
5.2 TO VERIFY OFFSET ACCURACY .....	32
5.3 TO VERIFY TIME BASE ACCURACY .....	34
5.4 TO VERIFY TRIGGER DELAY .....	35
5.5 TO VERIFY EXT TRIGGER DELAY .....	36
5.6 TO VERIFY EXT TRIGGER LEVEL .....	37
5.7 TO VERIFY NOISE FLOOR .....	39
5.8 TO VERIFY BANDWIDTH .....	40
5.9 TO VERIFY BANDWIDTH LIMIT .....	41
5.10 TO VERIFY TRIGGER SENSITIVITY .....	43
5.11 TO VERIFY INPUT IMPEDANCE .....	45

---







<b>6</b>	<b>DISASSEMBLY PROCEDURES.....</b>	<b>48</b>
6.1	SAFETY CONSIDERATION AND CAUTIONS .....	48
6.2	TOOLS LISTS.....	49
6.3	DISASSEMBLY PROCEDURES .....	50
6.3.1	<i>To Remove the Rear Cover and Knobs.....</i>	<i>50</i>
6.3.2	<i>To Remove the Power Supply Module and Fan .....</i>	<i>52</i>
6.3.3	<i>To Remove the Front Panel and Rubber Keypad.....</i>	<i>53</i>
6.3.4	<i>To Remove the Keyboard and Probe Interface Board.....</i>	<i>54</i>
6.3.5	<i>To Remove the Acquisition board.....</i>	<i>55</i>
6.3.6	<i>To Remove the LCD Module and LCD Interface Board.....</i>	<i>56</i>
<b>7</b>	<b>SOLVING GENERAL PROBLEMS .....</b>	<b>57</b>
<b>8</b>	<b>TROUBLESHOOTING .....</b>	<b>59</b>
8.1	SAFETY CONSIDERATION AND CAUTIONS .....	59
8.2	REQUIRED EQUIPMENT.....	60
8.3	TROUBLESHOOTING FLOWCHART .....	60
8.4	TO CHECK THE POWER SUPPLY MODULE .....	62
8.5	TO CHECK THE ACQUISITION BOARD .....	63
8.5.1	<i>Acquisition Board SDY8.007.181C.....</i>	<i>63</i>
8.6	TO CHECK THE LCD .....	67
8.6.1	<i>To Check the LCD Power Supply.....</i>	<i>67</i>
8.6.2	<i>To Check the LCD Signal.....</i>	<i>68</i>

# 1 General Safety Summary

This chapter contains information and warnings that must be followed to keep the instrument operating under the appropriate safety conditions. In addition to the safety precautions specified in this section, you must also follow recognized safety procedures.

## 1.1 Safety Terms and Symbols

When the following symbols or terms appear on the front or rear panel of the instrument or in this manual, they indicate special care in terms of safety.

	This symbol is used where caution is required. Refer to the accompanying information or documentation to protect against personal injury or damage to the instrument.
	This symbol warns of a potential risk of shock hazard.
	This symbol is used to denote the measurement ground connection.
	This symbol is used to denote a safety ground connection.
	This symbol shows that the switch is an On/Standby switch. When it is pressed, the scope's state switches between Operation and Standby. This switch does not disconnect the device's power supply. To completely power off the scope, the power cord must be unplugged from the AC socket after the oscilloscope is in the standby state.
	This symbol is used to represent an alternating current, or "AC".
CAUTION	The " <b>CAUTION</b> " symbol indicates a potential hazard. It calls attention to a procedure, practice, or condition which may be dangerous if not followed. Do not proceed until its conditions are fully understood and met.
WARNING	The " <b>WARNING</b> " symbol indicates a potential hazard. It calls attention to a procedure, practice, or condition which, if not followed, could cause bodily injury or death. If a WARNING is indicated, do not proceed until the safety conditions are fully understood and met.

## 1.2 Working Environment

This instrument is intended for indoor use and should be operated in a clean, dry environment with an ambient temperature range of 0 °C - 40 °C.

### Temperature

Operating: 0 °C to +40 °C

Non-operation: -20 °C to +60 °C

### Humidity

Operating: 85% RH, 40 °C, 24 hours

Non-operating: 85% RH, 65 °C, 24 hours

### Altitude

Operating: ≤ 3,000 m

Non-operating: ≤ 15,000 m

**Note:** Direct sunlight, radiators, and other heat sources should be taken into account when assessing the ambient temperature.



**WARNING:** Do not operate the oscilloscope in an explosive atmosphere or wet and damp conditions.

The design of the instrument has been verified to conform to EN 61010-1 safety standard per the following limits:

- Installation (overvoltage) Category: II (Mains Supply Connector)

- Degree of Pollution: II
- Degree of Ingress Protection: IP20

**Note:**

Installation (Overvoltage) Category II refers to the local distribution level, which applies to equipment connected to the mains supply (AC power source).

Degree of Pollution II refers to a working environment which is dry and non-conductive pollution occurs. Occasional temporary conductivity caused by condensation is expected.



**CAUTION:** Protect the display touch screen of the scope from excessive impact.



**CAUTION:** Do not exceed the maximum specified front panel terminal (CH1, CH2, CH3, CH4, EXT) voltage levels. Refer to Specifications for more details.



**CAUTION:** Do not connect or disconnect probes or test leads while they are connected to a voltage source.

### 1.3 Cooling Requirements

This instrument relies on forced air cooling with internal fans and ventilation openings. Care must be taken to avoid restricting the airflow around the apertures (fan holes) at each side of the scope. To ensure adequate

ventilation it is required to leave a 15 cm (6 inch) minimum gap around the sides of the instrument.



**CAUTION:** Do not block the ventilation holes located on both sides of the scope.



**CAUTION:** Do not allow any foreign matter to enter the scope through the ventilation holes, etc.

## 1.4 AC Power

The instrument operates with a single-phase, 100 to 240 Vrms (+/-10%) AC power at 50/60 Hz (+/-5%), or single-phase 100 - 120 Vrms (+/-10%) AC power at 400 Hz (+/-5%).

No manual voltage selection is required because the instrument automatically adapts to line voltage.

Depending on the type and number of options and accessories (probes, PC port plug-in, etc.), the instrument can consume up to 100 W of power.

**Note:** The instrument automatically adapts to the AC line input within the following ranges:

Voltage Range:	90 - 264 Vrms	90 - 132 Vrms
Frequency Range:	47 - 63 Hz	380 - 420 Hz

## 1.5 Power and ground connections

The instrument includes a grounded cord set containing a molded three-terminal polarized plug and a standard IEC320 (Type C13) connector for making line voltage and safety ground connection. The AC inlet ground terminal is connected directly to the frame of the instrument. For adequate protection against electrical shock hazard, the power cord plug must be inserted into a mating AC outlet containing a safety ground contact. Use only the power cord specified for this instrument and certified for the country of use.

**Warning:** Electrical Shock Hazard!

Any interruption of the protective ground conductor within or outside of the scope or disconnection of the safety ground terminal creates a hazardous situation.

Intentional interruption is prohibited.

The position of the oscilloscope should allow easy access to the socket. To make the oscilloscope completely power off, unplug the instrument power cord from the AC socket.

The power cord should be unplugged from the AC outlet if the scope is not to be used for an extended period.



**CAUTION:** The outer shells of the front panel terminals (CH1, CH2, CH3, CH4, EXT) are connected to the instrument's chassis and therefore to the safety ground.



## 1.6 Calibration

The recommended calibration interval is one year. Calibration should be only performed by qualified personnel.

## 1.7 Cleaning

Clean only the exterior of the instrument, using a damp, soft cloth. Do not use chemicals or abrasive elements. Under no circumstances allow moisture to penetrate the instrument. To avoid electrical shock, unplug the power cord from the AC outlet before cleaning.



**Warning:** Electrical Shock Hazard!

No operator serviceable parts inside. Do not remove covers.

Refer servicing to qualified personnel

## 1.8 Abnormal Conditions

Only operate the instrument for the purposes specified by the manufacturer.

Do not operate the scope if there are any visible signs of damage or if it has been subjected to severe transport stresses.

If you suspect the scope's protection has been impaired, disconnect the power cord and secure the instrument against any unintended operation.

Proper use of the instrument requires reading and understanding all of the instructions and labels.



**Warning:** Any use of the scope in a manner not specified by the manufacturer may impair the instrument's safety protection. This instrument should not be directly connected to human subjects or used for patient monitoring.

## 2 First steps

### 2.1 Delivery Checklist

First, verify that all items listed on the packing list have been delivered. If you note any omissions or damage, please contact your nearest SIGLENT customer service center or distributor as soon as possible. If you fail to contact us immediately in case of omission or damage, we will not be responsible for replacement.

### 2.2 Quality Assurance

The oscilloscope has a 3-year warranty (1-year warranty for probes) from the date of shipment, during normal use and operation. SIGLENT can repair or replace any product that is returned to the authorized service center during the warranty period. We must first examine the product to make sure that the defect is caused by the process or material, not by abuse, negligence, accident, abnormal conditions, or operation.

SIGLENT shall not be responsible for any defect, damage, or failure caused by any of the following:

- a) Attempted repairs or installations by personnel other than SIGLENT.
- b) Connection to incompatible devices/incorrect connection.
- c) The use of non-SIGLENT accessories or supplies. Furthermore, SIGLENT shall not be obligated to service a product that has been modified. Spare, replacement parts and repairs have a 90-day warranty.

The oscilloscope's firmware has been thoroughly tested and is presumed to be functional. Nevertheless, it is supplied without warranty of any kind covering detailed performance. Products not made by SIGLENT are covered solely by the warranty of the original equipment manufacturer.

## **2.3 Maintenance Agreement**

We provide various services based on a maintenance agreement. We offer extended warranties as well as installation, training, enhancement, on-site maintenance, and other services through specialized supplementary support agreements. For details, please consult your local SIGLENT customer service center or distributor.

### 3 Document Conventions

For convenience, text surrounded by a box border is used to represent the button of the front panel. For example, **Print** represents the "Print" button on the front panel. Italicized text with shading is used to represent the touchable or clickable menu/button/region on the touch screen. For example, **DISPLAY** represents the "DISPLAY" menu on the screen:

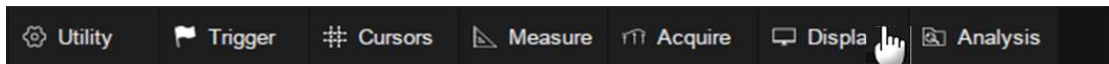

For the operations that contain multiple steps, the description is in the form of "Step 1 > Step 2 >...".As an example, follow each step in the sequence to enter the upgrade interface:

**Utility** > **System Setting** > **Upgrade**

Press the **Utility** button on the front panel as step 1, click the **System Setting** option on the screen as step 2, and click the **Update** option on the screen as step 3 to enter the upgrade interface.

## 4 Prepare Information

Before initiating performance verification or any adjustments, it is recommended the user follow these procedures. The following topics are discussed in this chapter.

- How to perform functional checks
- How to operate four standard interface tests
- How to use the self-calibration routine
- How to recall factory default settings

For more detailed information about oscilloscope operation, please refer to the User Manual.

### 4.1 Functional Checks

The functional checks details four types of checks used to determine if the oscilloscope is operating properly.

#### 4.1.1 Power-on Inspection

The standard power supply for the instrument is 100~240 V, 50/60 Hz, or 100~120 V, 400 Hz. Please use the power cord provided with the instrument to connect it to AC power.



Figure 1 Connect the power cord



**CAUTION:** To avoid electric shock, make sure that the instrument is correctly grounded to the earth before connecting AC power.

Press the Power button located at the lower-left corner of the front panel and note that several buttons will be lit for about 6 seconds simultaneously until the boot screen appears. The oscilloscope will then begin to perform its power-on tests automatically, after which the **Default** button can be pressed to recall the factory default settings.

### 4.1.2 Probe Compensation

When a probe is used for the first time, you should compensate it to match the input channel of the oscilloscope. Non-compensated or poorly compensated probe may increase measurement inaccuracy or error. The probe compensation procedures are as follows:

1. Connect the coaxial cable interface (BNC connector) of a passive probe to any channel of the oscilloscope.
2. Connect the probe to the "Compensation Signal Output Terminal" (Cal) on the front of the oscilloscope. Connect the ground alligator clip of the probe to the "Ground Terminal" under the compensation signal output terminal.



3. Press the **Auto Setup** button.
4. Check the waveform displayed and compare it with the following.

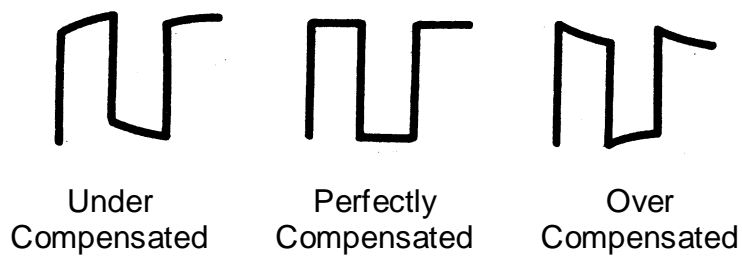

5. Use a non-metallic driver to adjust the low-frequency compensation adjustment hole on the probe until the waveform displayed is as the "Perfectly compensated" in the figure above.



### 4.1.3 Auto Setup

Press the **Auto Setup** button to enable the waveform auto setting function.

The oscilloscope will automatically adjust the horizontal time base, vertical scale, and trigger mode according to the input signal to obtain an optimum waveform display.

- Auto Setup will not work on all signal types, especially time-varying bursts or slow signals (< 100 Hz). If Auto Setup cannot achieve the desired settings, you can manually adjust the vertical, horizontal, and trigger systems.
- Select the channel with the lowest frequency when several channels are connected to signals.

#### 4.1.4 Self-Calibration

The self-calibration program can quickly calibrate the oscilloscope to reach the best working state and the most precise measurement. It is recommended to perform a self-calibration if the change of ambient temperature is more than 5 °C. Make sure the oscilloscope has been warmed up or operated for more than 30 minutes before running self-calibration.

Please perform the self-calibration as follows:

1. Disconnect everything from all inputs.
2. Operate Utility>Do Self Cal, and it will pop up the following dialog. Select Continue to start the self-cal program.

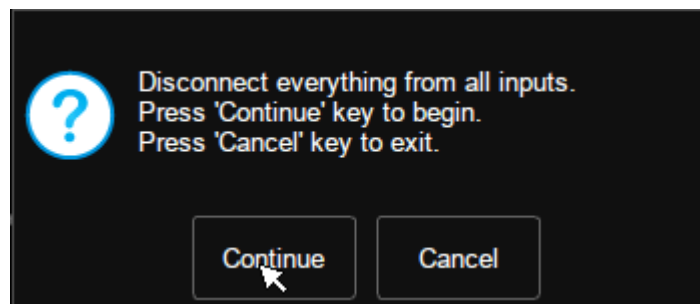

Figure 2 Calibration Interface

3. The oscilloscope will not respond to any operations until the self-cal is finished. After the self-cal is completed, touch the screen or press any button to exit.

## 4.2 Interface Test

The SDS2000X Plus series oscilloscope is designed with four standard interfaces: USB Host, USB Device, LAN, and Pass/Fail. Connecting to other instruments via these interfaces enables the oscilloscope to achieve additional capabilities. To ensure the oscilloscope is operating properly, it is recommended that the user first test the interfaces.

### 4.2.1 USB Host Test

To test whether the USB Host interface is operating correctly.

**Tools:**

A U-disk

**Steps:**

1. Insert a U-disk (flash drive) into the USB Host interface on the front panel of the oscilloscope.
2. A message prompt "USB flash drive detected." appears on the screen, and an icon will be shown in the lower right corner of the screen which confirms the U-disk has been successfully recognized.



Figure 3 USB drive detected

## 4.2.2 USB Device Test

To test if the USB Device interface is operating correctly.

### Tools:

- A computer with a USB interface
- A standard USB cable (Type AB)
- National Instruments NI-Max software

### Steps:

1. Set up the NI-Max software on a computer and install the driver step by step following the instructions.
2. Connect the oscilloscope to the computer using a USB cable.
3. Run NI-MAX software. Click "Device and Interface" at the upper left corner

of the NI software interface and immediately the “USBTCM” device symbol is displayed.

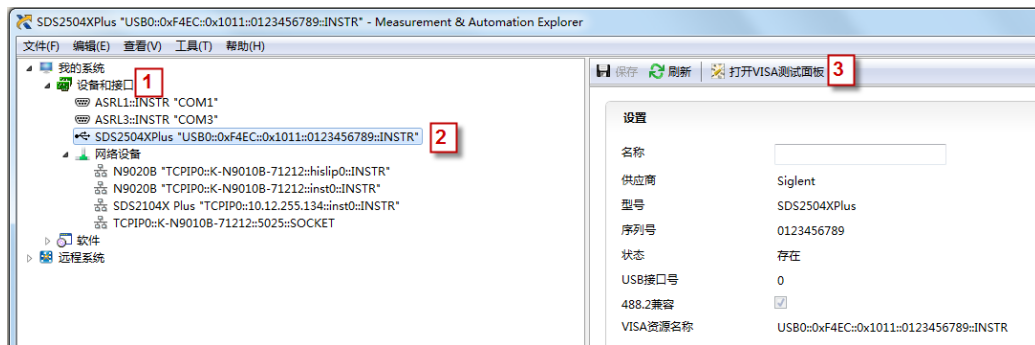

- Click “Open VISA Test Panel” option button, and then the following Interface will appear. Next, click the “Input/Output” option button and click the “Query” option button to view the Read operation information.

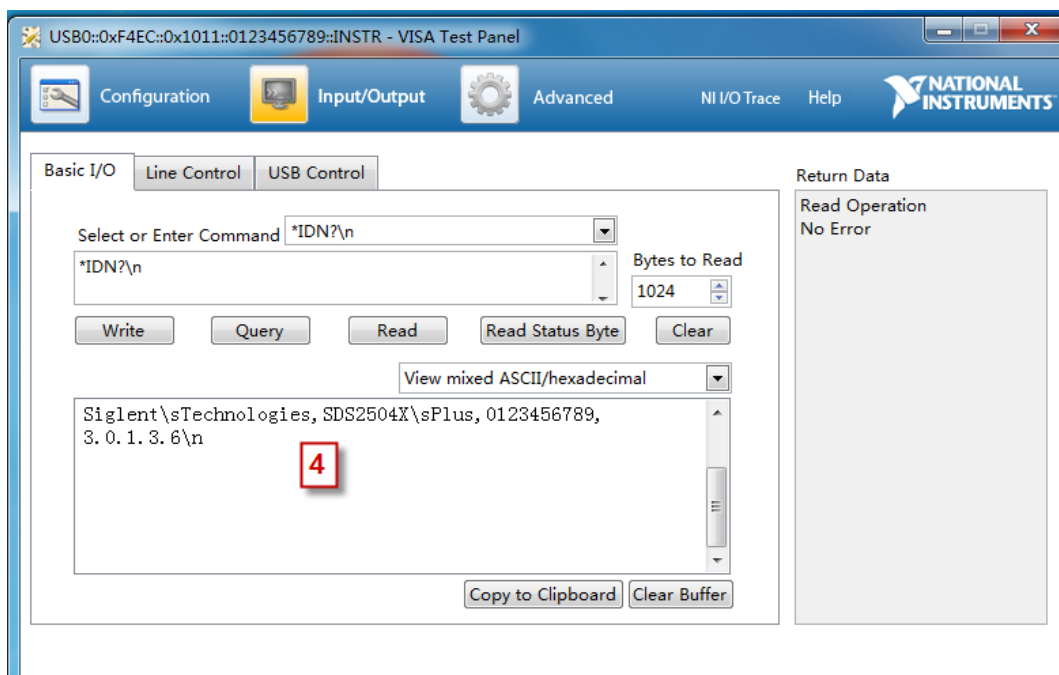

### 4.2.3 LAN Port Test

Use to test if the LAN interface operates correctly when connected with NI Visa software.

#### Tools:

- A computer with a LAN interface
- A standard LAN cable
- National Instruments NI-MAX software

#### Steps:

1. Set up the NI-MAX software on a computer and install the driver using the following instructions.
2. Perform Utility>System Setting>I/O Setting>LAN Config to open the LAN Config dialog box. And input usable IP Address and Subnet Mask.

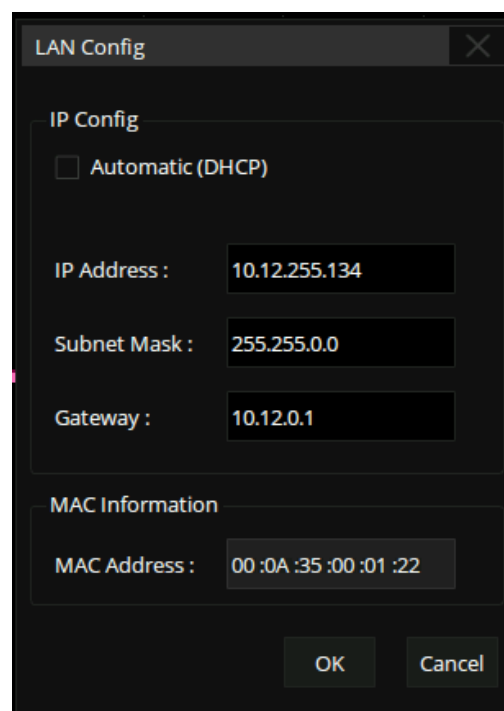
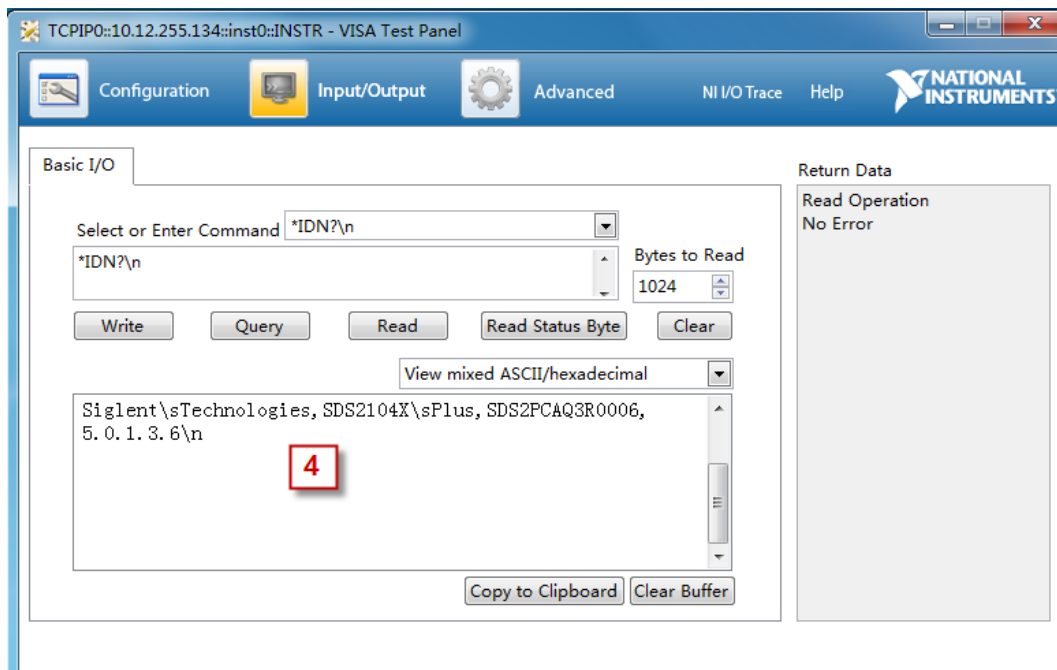

Figure 4 IP Setting interface

1. Connect the oscilloscope to the computer using a LAN cable via the LAN interface ports.
2. Run NI-MAX software. Click “Device and Interface” at the upper left corner of the NI software interface and select the “LAN” device symbol.



3. Click “Open VISA Test Panel” option button, which then displays the following interface (below). Then click the “Input/Output” option button and click the “Query” option button. The “Read” operation information will be displayed.



#### 4.2.4 Pass/Fail out Test

To test the Mask Test function and signal output by viewing on another oscilloscope.

##### Tools:

- A second oscilloscope
- Two BNC cables

##### Steps:

1. Turn on the SDS2000X Plus oscilloscope.
2. Enable Channel 1.
3. Perform **Analysis** > **Mask** Test to open the Mask Test dialog box, and touch **Mask Setup** > **Create Mask** to set the mask. Set the items as below:

Table 1 Mask Test Settings

Parameter	Setting
Enable to Test	On
Source	CH1
Type	All in
Display Info	On
Mask Setting	
Mask X	0.32
Mask Y	0.32

**Note:** press **Create Mask** to complete Mask setting, after mask x setting and mask y setting.

After selecting the corresponding items as shown in the table above, the screen will appear as in Figure 5:



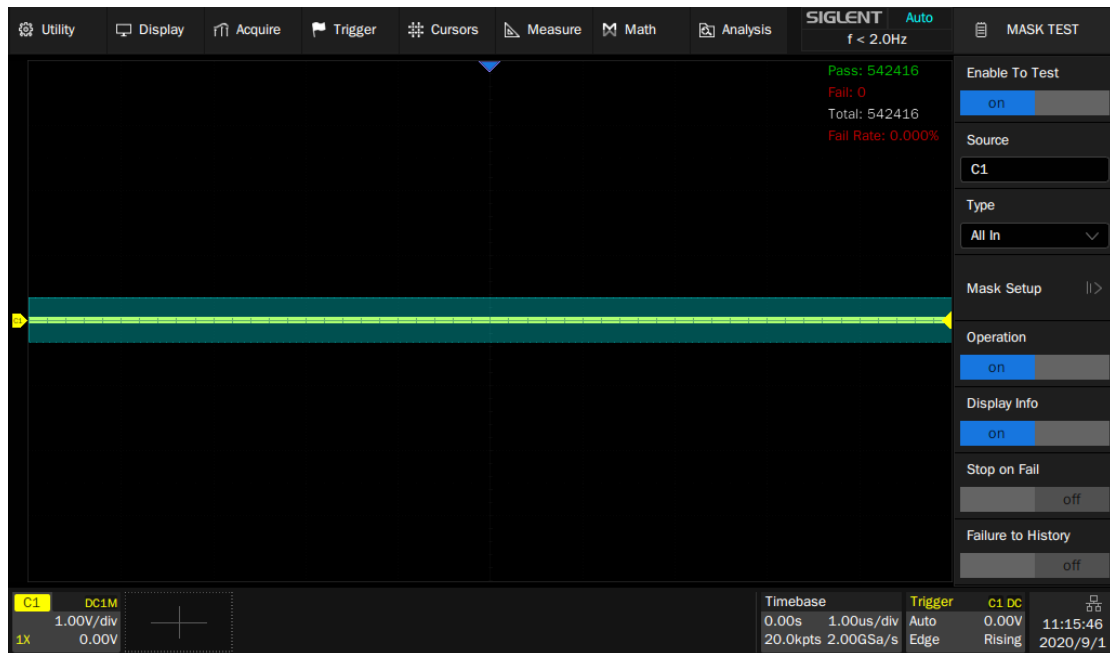

Figure 5 Mask Test Interface

All data points of waveform must be inside the mask to pass the test. Even a single point outside the mask will cause a failure.

1. Connect the Pass/Fail output signal (on the rear panel) to the input terminal of another oscilloscope.
2. Move the waveform on the screen up, down, or sideways so that any portion of it falls outside of the Pass/Fail mask. If the interface is operating normally then a pulse will appear on the second oscilloscope. Adjust the second oscilloscope's time base and voltage scale as needed. If there is no viewable pulse on the second oscilloscope then there may be a problem with this function.

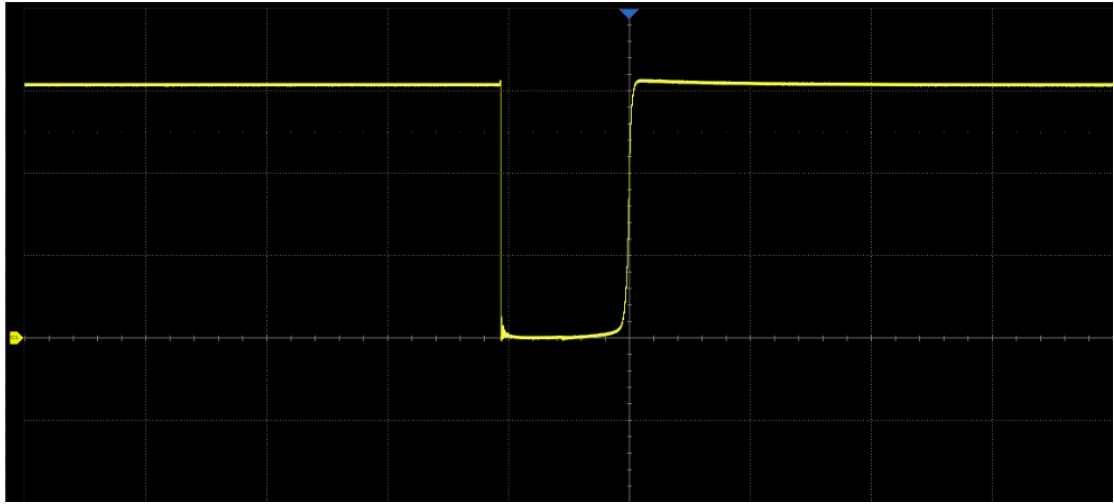

Figure 6 Pulse Waveform

## 5 Performance Test

This chapter explains testing the oscilloscope to verify performance specifications. For accurate test results, please let the test instruments and the oscilloscope warm-up 30 minutes before testing.

Below is the required equipment for the test:

Table 2 Test equipment

Equipment	Description	Test item
Fluke 9500B + Active Heads	High-Performance Oscilloscope Calibrator	DCG¥Offset¥ Clock accuracy¥Trigger delay ¥BW¥BWL¥trigger sensitivity¥ Input impedance¥ Ext Trigger delay¥Ext Trigger level...
GPIB Card and Cable	For communication between the computer and the 9500B	
USB Cable(or Ethernet Cable)	For communication between the computer and the SDS2000X Plus	
BNC Cables	BNC(m) to BNC(m), Approx.1m long	
BNC T Connectors	For signal distribution	DCG¥Offset
Computer		

The figures below show the interconnections between the test equipment and PC to the oscilloscope under test:

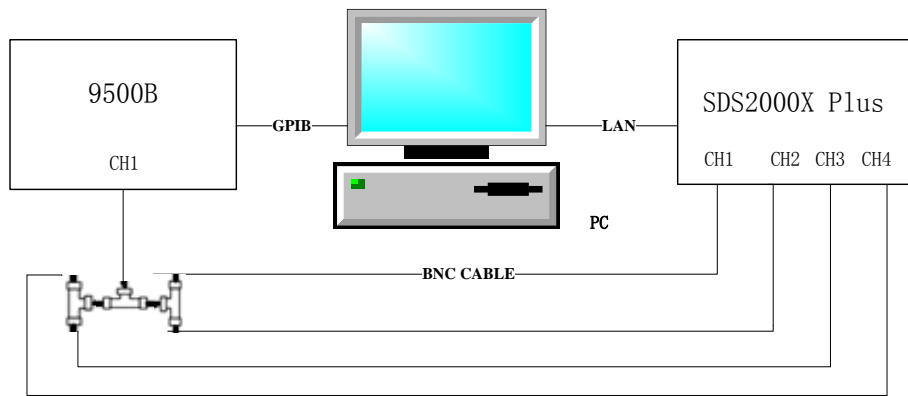

Figure 7 Connecting test instruments for DCG\Offset

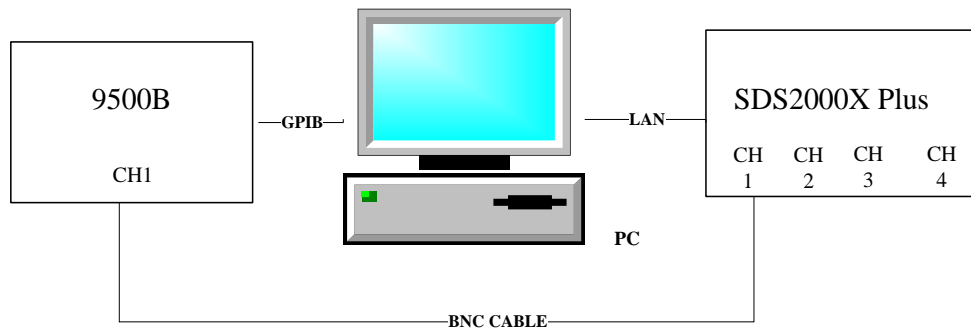

Figure 8 Connecting test instruments for Clock\Trigger Delay

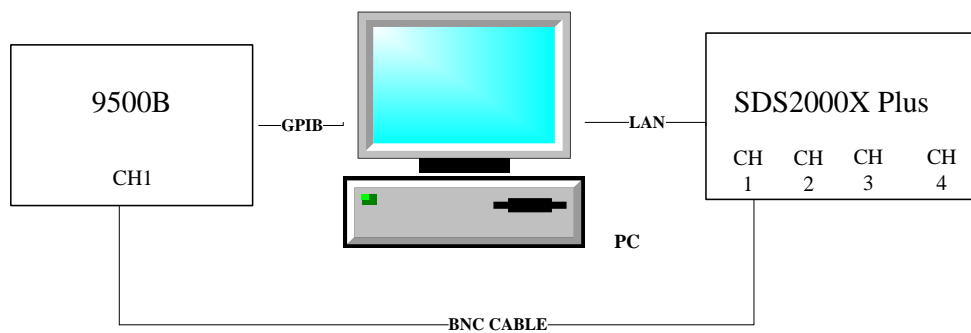

Figure 9 Connecting test instruments for BW\BWL\Trigger Sensitivity

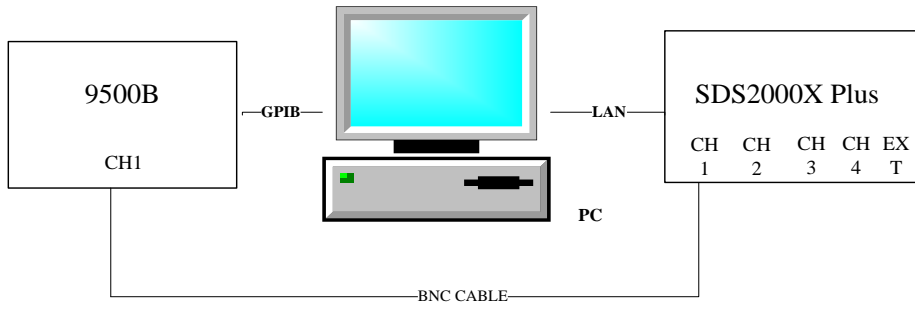

Figure 10 Connecting test instruments for Input impedance

The figures below show the interconnections between the test equipment and PC to Ext Trigger test:

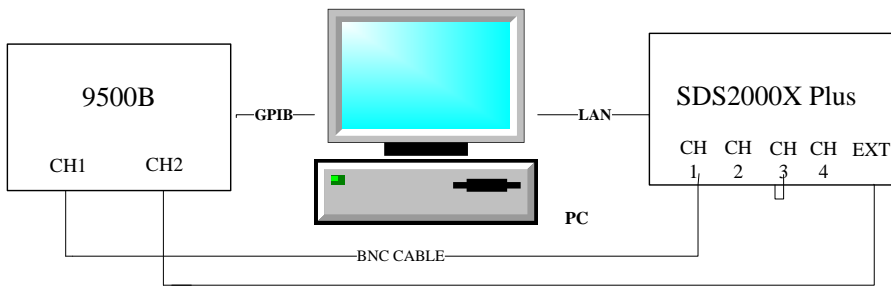

Figure 11 Connecting test instruments for Ext Trigger Delay\ Ext Trigger Level

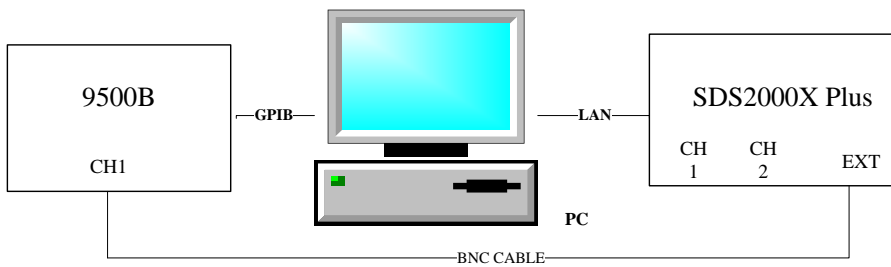

Figure 12 Connecting test instruments for Ext Trigger Sensitivity

## **Verify Test Results**

To verify whether or not a test passes (i.e. whether the readings are within the appropriate limits), it is necessary to record the readings in the Performance Test located in the Test Record.

## **Self-Calibration**

The Self Calibration procedure is described in section **Self-Calibration**. If the environmental temperature changes by more than 5°C, the Self Calibration operation must be performed to achieve the specified performance.

## 5.1 To Verify DC Gain Accuracy

**DC Gain Accuracy Slope =  $\text{LINEST}(V_{\text{error}1}:V_{\text{error}5}, V_{\text{Setting}1}:V_{\text{Setting}5})$**

**Note:** “ $V_{\text{Setting}}$ ” represents the DC voltage output level setting.

“ $V_{\text{error}}$ ” represents the difference between the output setting and the measurement.

This test verifies non-interleaved mode DC Gain Accuracy of all channels.

### Steps:

1. Set the 9500B output to on.
2. Connect all channels of the oscilloscope to the 9500B as shown in Figure 7.
3. Set Volts/Div of the oscilloscope to 1 mV/div. Press the **Measure** button on the front panel of the oscilloscope to display Mean measurement.
4. Set DC voltage output level of the 9500B according to Table 3, and record the mean value of the oscilloscope as  $V_{\text{mean}}$ .
5. Calculate  $V_{\text{error}}$  ( $V_{\text{error}}=V_{\text{Setting}} - V_{\text{mean}}$ ), and set the next output level as step 4.
6. Make a linear regression with these 5 data points:  $V_{\text{Setting}1}\sim V_{\text{Setting}5}$ ,  $V_{\text{error}1}\sim V_{\text{error}5}$ . Check if the slope falls within the range shown in Table 3.
7. Set the oscilloscope Volts/Div to the other settings in Table 3, and repeat step 4 to step 6.
8. Turn the 9500B output off.
9. Disconnect the connections to all the channels.

Table 3 DC Gain Accuracy

Volt/Div	DC voltage output levels	DC Gain Accuracy error
10 V/div	30 V, 15V, 0, -15 V, -30 V	±3%
5 V/div	15 V, 7.5 V, 0, -7.5 V, -15 V	±3%
2 V/div	6 V, 3 V, 0, -3 V, -6 V	±3%
1 V/div	3 V, 1.5 V, 0, -1.5 V, -3 V	±3%
500 mV/div	1.5 V, 0.75 V, 0, -0.75 V, -1.5 V	±3%
200 mV/div	600 mV, 300 mV, 0, -300 mV, -600 mV	±3%
100 mV/div	300 mV, 150 mV, 0, -150 mV, -300 mV	±3%
50 mV/div	150 mV, 75 mV, 0, -75 mV, -150 mV	±3%
20 mV/div	60 mV, 30 mV, 0, -30 mV, -60 mV	±3%
10 mV/div	30 mV, 150 mV, 0, -150 mV, -30 mV	±3%
5 mV/div	15 mV, 7.5 mV, 0, -7.5 mV, -15 mV	±3%
2 mV/div	6 mV, 3 mV, 0, -3 mV, -6 mV	±3%
1 mV/div	3 mV, 1 mV, 0, -1 mV, -3 mV	±3%

## 5.2 To Verify Offset Accuracy

**Offset Accuracy Slope = LINEST(Offset<sub>error1</sub>:Offset<sub>error5</sub>, Offset<sub>out1</sub>:Offset<sub>out5</sub>)**

**Note:** “Offset<sub>out</sub>” represents DC voltage output level setting;

“Offset<sub>error</sub>” represents the difference between the output setting and the measurement.



This test verifies the non-interleaved mode Offset Accuracy of all the channels.

**Steps:**

1. Set the 9500B output to on.
2. Connect all channels of the oscilloscope to 9500B as shown in Figure 7.
3. Set the Volts/Div of the channel to 1 mV/div. Press the **Measure** button on the front panel of the oscilloscope to display Mean measurement.
4. According to Table 4, set offset of the channel to -Offset, and set the 9500B output level to equal the offset, then record the mean value of the oscilloscope as  $V_{mean}$ . When the offset is 0, set the 9500B output to off and record the mean value of the oscilloscope as  $V_{zero}$ .
5. Calculate Offseterror ( $Offseterror = V_{mean} - Offset$ ), and adjust the 9500B to the output level as step 4.
6. Make a linear regression with these 5 data points:  
Offseterror1~Offseterror5, Offsetout1~Offsetout5. Check to verify that the slope is within the limits specified in Table 4.
7. Check to verify that  $abs(V_{zero})$  in step 4 is within the limits specified in Table 4.
8. Set the oscilloscope Volts/Div to the other settings in Table 4, and repeat steps 4 to 6.
9. Turn the 9500B output off.
10. Disconnect the connections to all the channels.

Table 4 Offset Accuracy

Volt/Div	Offset	Slope error	Zero input(V)
10 V/div	35 V,30 V,0,-30 V,-35 V	±1.5%	±1.202
5 V/div	30 V,25 V,0,-25 V,-30 V	±1.5%	±0.602
2 V/div	20 V,10 V,0,-10 V,-20 V	±1.5%	±0.242
1 V/div	10 V,5 V,0,-5 V,-10 V	±1.5%	±0.122
500 mV/div	5 V,2.5 V,0,-2.5 V,-5 V	±1.5%	±0.062
200 mV/div	2 V,1 V,0,-1 V,-2 V	±1.5%	±0.026
100 mV/div	1 V,0.5 V,0,-0.5 V,-1 V	±1.5%	±0.014
50 mV/div	500 mV,250 mV,0,-250 mV,-500 mV	±1.5%	±0.008
20 mV/div	200 mV,100 mV,0,-100 mV,-200 mV	±1.5%	±0.0044
10 mV/div	100 mV, 50 mV,0,- 50 mV,-100 mV	±1.5%	±0.0032
5 mV/div	50 mV,25 mV,0,-25 mV,-50 mV	±1.5%	±0.0026
2 mV/div	20 mV, 10 mV,0,-10 mV, -20 mV	±1.5%	±0.00224
1 mV/div	10 mV, 5 mV,0,-5 mV, -10 mV	±1.5%	±0.00224

### 5.3 To Verify Time Base Accuracy

This test verifies the time base accuracy of the oscilloscope. In the test, the impedance of both the 9500B and the oscilloscope should be set to 1 MΩ.

#### Time Base Accuracy: Frequency Error < 10 Hz

#### Steps:

1. Connect the selected channel of the oscilloscope to the 9500B.
2. Set the oscilloscope Volts/Div to 100 mV/div.
3. Set the oscilloscope Sec/Div to 50 ms/div.
4. Set the Memory Depth to 20Mpts.
5. Set waveform of the 9500B to sine, amplitude to 600 mV, and frequency to the value (10 MHz).
6. Check if the trigger (hardware-measured) frequency which is on the top right of the screen is in the range of 999910~1000010.
7. Disconnect the test connection.
8. To Verify Trigger Delay
9. This test checks the trigger delay of the analog channels. In this test, the impedance of both the 9500B and the oscilloscope should be set to 50  $\Omega$ .

## 5.4 To Verify Trigger Delay

This test checks the trigger delay of the analog channels. In this test, the impedance of both the 9500B and the oscilloscope should be set to 50  $\Omega$ .

**Channel Trigger Delay Limit:  $\text{abs}(T@L) \leq 150 \text{ ps}$**

### Steps:

1. Connect the selected channel of the oscilloscope to the 9500B shown as in Figure 8.
2. Press the 'Aux' key at the right of the 'OSCILLOSCOPE CALIBRATOR' panel of the 9500B and select Skew function.

3. Set the impedance of the 9500B to 50  $\Omega$ , frequency to 1 kHz, and amplitude to 0.6 V.
4. Set the oscilloscope Volts/Div to 100 mV/div.
5. Set the oscilloscope Sec/Div to 2 ns/div, trigger source is the selected channel.
6. Press the Measure button on the front panel of the oscilloscope to display Time@Level measurement.
7. Check if the result is in the limited range above.
8. Disconnect the test connection.
9. Check other channels in the same way as steps 1 to 7.

## 5.5 To Verify Ext Trigger Delay

This test checks the trig delay between the external trigger channel and analog channels. In the test, the impedance of the 9500B should be set to 50  $\Omega$ , and external channel and selected analog channel both set to 50  $\Omega$ .

**CH-Ext Trigger Delay Limit:  $\text{abs}(\text{Delay}) \leq 1 \text{ ns}$**

### Steps:

1. Connect selected analog channel and external channel of the oscilloscope to the 9500B with active heads (CH1/CH2) shown as in Figure 11.
2. Press the 'Aux' key at the right of the 'OSCILLOSCOPE CALIBRATOR' panel of the 9500B and select the Skew function.
3. Set the impedance of the 9500B to 50  $\Omega$ , frequency to 1 kHz, and

amplitude to 0.6 V.

4. Set the oscilloscope Volts/Div to 100 mV/div.
5. Set the oscilloscope Sec/Div to 2 ns/div.
6. Set the oscilloscope trigger source to EXT, the trigger slope to Rising, and the trigger level to 0.
7. Press **Measure** button on the front panel of the oscilloscope to display Delay measurement.
8. Check if the delay is within the limited range above ( $\leq 1$  ns).
9. Disconnect the test connection.
10. Check the other analog channel in the same way as steps 1 to 9.

## 5.6 To Verify Ext Trigger Level

This test checks the trigger level accuracy of the external trigger channel. In this test, the impedance of both the 9500B and the oscilloscope should be set to 1 M $\Omega$ .

Table 5 EXT Trigger Level Error Limit

Trigger Channel	Volt/div	Trigger Level Error Limited Range
EXT	150 mV	Abs(Error) < 45mV
EXT/5	435 mV	Abs(Error) < 103.5mV

### Steps:

1. Connect channel 1 and external trigger channel of the oscilloscope to the

- 9500B with a BNC T connector, as shown in Figure 11.
2. Set the oscilloscope Sec/Div to 50 us/div.
  3. Set the oscilloscope Volts/Div to 150 mV/div, trigger source to EXT, trigger slope to positive, and coupling mode to DC.
  4. Set the impedance of the 9500B to 1 M $\Omega$ , frequency to 2 kHz, amplitude to 4\* Volts/Div, and waveform to sine.
  5. Set the trigger level to 450 mV.
  6. Press the Measure button on the front panel of the oscilloscope to display Level@x measurement.
  7. Record the value of Level@x, calculate the level error (error = 300 mV - Level@x).
  8. Check if the trigger level error is in the limited range above.
  9. Set the trigger level to 0 mV and -450 mV, repeat step 5 to step 8.
  10. Set trigger slope to negative, repeat step 5 to step 9.
  11. Set the oscilloscope Volts/Div to 345mV/div, trigger source to EX/5, trigger slope to positive, and coupling mode to DC.
  12. Set the impedance of the 9500B to 1 M $\Omega$ , frequency to 2 kHz, amplitude to 4\* Volts/Div, and waveform to sine.
  13. Set the trigger level to 1035 mV.
  14. Record the value of Level@x, calculate the level error (error = 300 mV - Level@x).
  15. Check if the trigger level is in the limited range in Table 5.
  16. Set the trigger level to 0mV and -1035 mV, repeat step 13 to step 15.
  17. Set trigger slope to negative, repeat step 13 to step 16.

18. Disconnect the test connection.

## 5.7 To Verify Noise Floor

This test checks the noise floor of the analog channels and varies from models. In this test, do not connect any testing devices to the oscilloscope.

Table 6 Noise Floor Limited Range

Volt/Div	SNR Limited Range	Volt/Div	SNR Limited Range
500 uV	[21,70]	100 mV	[38,70]
1 mV	[22,70]	200 mV	[38,70]
2 mV	[27,70]	500 mV	[38,70]
5 mV	[31,70]	1 V	[38,70]
10 mV	[35,70]	2 V	[38,70]
20 mV	[38,70]	5 V	[38,70]
50 mV	[38,70]	10 V	[38,70]

### Steps:

1. Set the oscilloscope Sec/Div to 1 ms/div.
2. Set the oscilloscope Volts/Div to 500 uV/div.
3. Press the **Measure** button on the front panel of the oscilloscope to display Stdev and Peak-Peak measurement.
4. Calculate SNR ( $SNR = 20 * \log_{10} \frac{8*vdiv}{2*\sqrt{2}*stdev}$ ).
5. Check if the SNR and pkpk/stdev are in the limited range shown in Table 5.
6. Check the other analog channels in the same way as steps 1 to 5.

- Set the oscilloscope Volts/Div to the others in the table above, and repeat steps 3 to 5.

## 5.8 To Verify Bandwidth

This test checks the bandwidth of all analog channels. In the test, the impedance of 9500B should be set to be the same as analog channels, 50  $\Omega$ , and 1 M $\Omega$ . The bandwidth should be verified at each coarse Volts/DIV, except for 1 mV/div and 2 mv/div.

### Steps:

- Connect the selected channel of the oscilloscope to the 9500B via the active head, as shown in Figure 9.
- Set the oscilloscope Volts/Div to 5 mV/div, the Sec/Div to 500 us/div, impedance to 50  $\Omega$ .
- Press the **Measure** button on the front panel of the oscilloscope to display Peak-Peak measurement.
- Set waveform of the 9500B to sine, amplitude to 30 mV, and impedance to 50  $\Omega$ , and set the impedance of the oscilloscope channels to 50  $\Omega$ .
- Set frequency of the 9500B to the frequency in Table 7.

Table 7 Frequency points in the test

Scope Model	Impedance	Frequency Point (Hz)
SDS2504X	50 $\Omega$	0.05M,21M,52M,74M,121M,168M,201M,234M,268M,301M,334M,367M,401M,434M,468M,500M,601M,801M



1. Every time the frequency is changed, it is recommended to adjust the Sec/Div to a proper value to display a complete waveform.
2. Record the Peak-Peak measurement of the waveform.
3. Set the oscilloscope Volts/Div to the setting choices, and repeat step 2 to step 7. Set amplitude of the 9500B to 600 mV when testing at 100 mV/div, and set to 1.2 V when testing at 200 mV/div.
4. Check other channels in the same way as step1 to step 8.
5. Disconnect the test connection
6. After the test, calculate the dB value at every frequent point. Check if the value is in the limited range in Table 8.

Table 8 Limited Range

Scope Model	Impedance	Frequency (Hz)	Point	Range
SDS5054X	50 $\Omega$	$\leq 52\text{M}$		(-0.5,0.5) dB
		$\leq 168\text{M}$		(-0.8,0.8) dB
		$\leq 334\text{M}$		(-1.2,1) dB
		$\leq 501\text{M}$		(-2.5,1) dB
		$\leq 1001\text{M}$		(-45,3) dB

## 5.9 To Verify Bandwidth Limit

This test checks the bandwidth limit of all the analog channels. The test is similar to the bandwidth test except that the bandwidth limit is turned on. In the test, the impedance of 9500B should be set to 50  $\Omega$ . Test the bandwidth at 100 mV/div, 200 mV/div

**Steps:**

1. Connect channel 1 of the oscilloscope to the 9500B via the active head, as shown in Figure 9.
2. Set the oscilloscope Volts/Div to 100 mV/div, the Sec/Div to 50 ms/div, and set the BW Limit button to 20 MHz.
3. Press the **Measure** button on the front panel of the oscilloscope to display Peak-Peak measurement.
4. Set the amplitude of the 9500B to 600 mV, and impedance to 50 Ω, and set the impedance of the oscilloscope channels to 50 Ω.
5. Set frequency of the 9500B to the frequency in Table 9.

Table 9 Frequency points in the test

Frequency Point (Hz)
1k,10k,100k,1M,10M,12M,14M,16M,18M,20M,22M,24M,26M,28M,30M

1. Every time the frequency is changed, it is recommended to adjust the Sec/Div to a value that displays a complete waveform.
2. Record the Peak-Peak measurement value of the waveform.

Table 10 Limited Range

Scope Model	Impedance	Frequency Point (Hz)	Range
SDS2504X Plus	50 Ω	≤12M	(-2,1.15) dB
		≤14M	(-2.4,2) dB
		≤20M	(-3.4,2) dB
		≤25M	(-6,2) dB
		≤30M	(-8,2) dB

1. Calculate the dB value at the frequency point. If the value Check if the value is in the limited range.
2. Check the other channels in the same way as in step1 to step 8.
3. Disconnect the test connection.

## 5.10 To Verify Trigger Sensitivity

This test checks trigger sensitivity at the frequency of 10 MHz and also at the bandwidth frequency.

In the test, the impedance of 9500B should be set to 50  $\Omega$ .

Table 11 Trigger sensitivity data

Volts/Div	Frequency	Trigger Range
100 mV/div	10 MHz	9.9~10.1 MHz
100 mV/div	bandwidth	bandwidth $\pm$ 1%

### Steps:

1. Connect the selected channel of the oscilloscope to the 9500B, as shown in Figure 9.
2. Set the oscilloscope Volts/Div to 100 mV/div, Sec/Div to 50 ns/div, coupling mode to AC.
3. Set impedance of the 9500B to 50  $\Omega$ , frequency to 10 MHz, and amplitude to 80 mV, and set the impedance of the oscilloscope channels to 50  $\Omega$ .
4. Set trigger slope of the oscilloscope to Positive.
5. Press Trigger Level knob to set the level to the center of the waveform.
6. Adjust the trigger level within the waveform range to achieve a stable trigger.

7. Record the (hardware-measured) frequency which is on the top right of the screen, and check that it is in the specified trigger range listed in Table 11.
8. Set the oscilloscope trigger slope to Negative, repeat steps 5 to 7.
9. Set frequency of the 9500B to the bandwidth frequency of the oscilloscope. Set Sec/Div to 2 ns/div, then repeat steps 4 to 8.
10. Check the other channels in the same way as steps 1 to 9.
11. Disconnect the test connection.

The steps above are for testing the trigger level when using the internal trigger using the analog input channels. The following steps are used to test the external trigger sensitivity.

**Steps:**

1. Connect the external trigger channel of the oscilloscope to the 9500B, as shown in Figure 12.
2. Set the impedance of the 9500B to 50  $\Omega$ , amplitude to 200 mV, frequency to 10 MHz.
3. Set the trigger source of the oscilloscope to EXT, trigger slope to Positive.
4. Press the Trigger Level knob to set the level to the center of the waveform.
5. Adjust the trigger level within the range of [-100 mV, 100 mV] to achieve a stable waveform and then record the (hardware-measured) frequency, located at the top right area of the screen.
6. Check if the frequency is within the specified trigger range listed in Table

- 10.
7. Set trigger slope to Negative, repeat steps 4 to 6.
8. Set frequency of the 9500B to the oscilloscope's bandwidth frequency, amplitude to 300 mV. Repeat steps 3 to 7. In step 5, the range changes to [-150 mV, 150 mV].
9. Set frequency of the 9500B to 10 MHz, amplitude to 1 V.
10. Set the trigger source of the oscilloscope to EXT/5, trigger slope to Positive.
11. Press the Trigger Level knob to set the level to the center of the waveform.
12. Adjust the trigger level within the range of [-500mV, 500mV] to achieve a stable waveform and then record the hardware-measured value which is on the top right of the screen.
13. Check if the frequency is within the specified range listed in Table 13.
14. Set the trigger slope to Negative, repeat steps 11 to 13.
15. Set the frequency of the 9500B to the oscilloscope's bandwidth frequency, amplitude to 1.5 V. Repeat steps 11 to 14. In step 6, the range changes to [-750 mV, - 750 mV].
16. Disconnect the test connection.

## 5.11 To Verify Input Impedance

This test checks the input impedance of all analog channels and the ext trigger channel with different coupling modes and vertical scales (100 mV/div, 200 mV/div, and 2 V/div).

Table 12 Input Impedance data

Channel	Coupling and impedance type	Impedance Range	
		0.1V/div	1176000~1224000 $\Omega$
CH	AC/1 M $\Omega$	0.2V/div, 2V/div	980000~1020000 $\Omega$
		DC/1 M $\Omega$	980000~1020000 $\Omega$
	DC(AC)/50 $\Omega$	49.15~50.85	
Ext	1 M $\Omega$	980000~1020000 $\Omega$	
	50 $\Omega$	49.15~50.85	

**Steps:**

1. Connect the selected channel of the oscilloscope to the 9500B, as shown in Figure 10.
2. Set the oscilloscope Volts/Div to 100 mV/div, coupling mode of the channel to AC.
3. Press the 'Aux' key at the right of the 'OSCILLOSCOPE CALIBRATOR' panel of the 9500B and select the Load Resistance Measurement Function. Record the reading displays on the screen of the 9500B.
4. Set the coupling mode of the channel to DC. Record the reading displays on the screen of the 9500B.
5. Check if the impedance is within the specified range in Table 12.
6. Test at 2 V/div and 200 mV/div, using the same procedure as steps 2 to 5.
7. Check the other analog channels in the same way as steps 1 to 6.
8. Disconnect the test connection

When checking the EXT trigger channel, it is the same as checking the analog channel. Record the reading displays on the screen of the 9500B, and check to verify it is within the specified range in Table 12.

## 6 Disassembly Procedures

This chapter describes how to remove major parts from the SDS2000X Plus series oscilloscope.

### 6.1 Safety Consideration and Cautions

Only qualified personnel should perform the disassembly procedures. Disconnect the power before you begin to remove or replace the parts. Otherwise, potential personal injuries or damages to the components may occur.

**WARNING****HAZARDOUS VOLTAGES**

Maintenance is performed with the power supply on and without protective covers. Only qualified personnel with proper tools and protection should perform maintenance. Perform maintenance with the power cord disconnected whenever possible.

---

**WARNING****AVOID ELECTRICAL SHOCK**

Hazardous voltages exist on the power supply and LCD modules. To avoid electrical shock, disconnect the power cord and wait at least three minutes for the capacitors to discharge before you begin disassembly.

---

**CAUTION****ESD CAUTION**

Electrostatic discharge (ESD) sensitive devices inside. Electronic components may be damaged without detection. Proper ESD precautions should be taken to avoid performance degeneration or loss of functionality. At a minimum, place the oscilloscope on a properly grounded ESD mat and wear a properly grounded ESD strap.

---



**CAUTION**



**REMOVE POWER TO AVOID DAMAGE**

Remove power before you start to disassemble or replace parts. DO NOT disassemble or replace parts with the power on. Damage to the components may occur.

---

## 6.2 Tools Lists

Use these tools to remove or replace the modules in the oscilloscope:

- Multi-function screwdriver
- Antistatic gloves
- Custom screw hexagonal nut tool or long nose pliers

## 6.3 Disassembly Procedures

This section describes how to remove the modules in the oscilloscope in detail. To install the removed parts or replace a new part, follow the instructions in reverse order.

### 6.3.1 To Remove the Rear Cover and Knobs

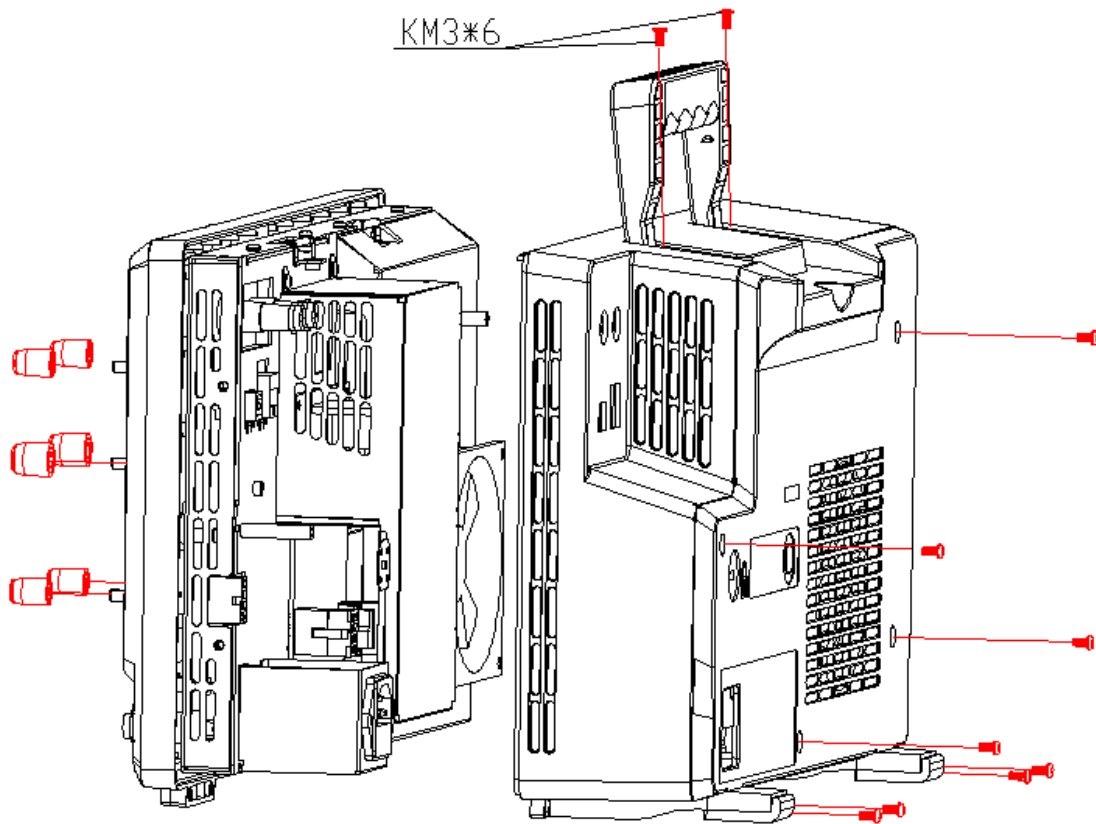

Figure 13 To remove the rear cover and knobs

Steps:

1. Remove each front-panel knobs by firmly grasping the knob (with pliers protected by a soft cloth to prevent scratches, if necessary) and pull it away from the front panel.
2. Remove the ten screws on the rear-cover (eight PM3\*8 screws, Two KM3\*6

screws).

3. Lift the rear cover up and off carefully.

### 6.3.2 To Remove the Power Supply Module and Fan

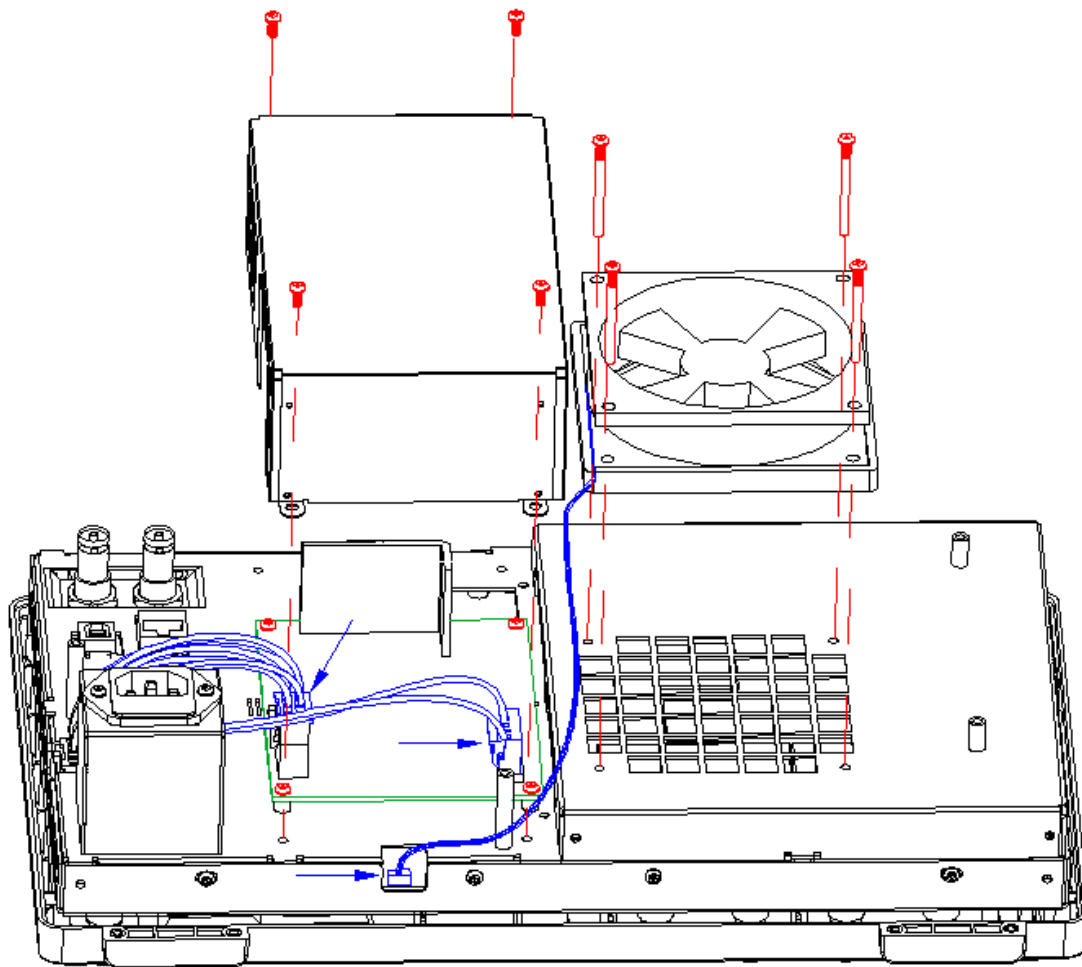

Figure 14 To remove the power supply module and Fan

Steps:

1. Remove the four PM3\*6 screws outside the Power Supply Module housing .
2. Remove the Power Supply Module housing.
3. Unplug the connecting cable from the power module.
4. Remove the four screws on the power supply module.
5. Remove the power supply module.
6. Unplug the fan connecting cable from the mainboard.
7. Remove the four KM3\*32 screws on the fan and remove the fan.

### 6.3.3 To Remove the Front Panel and Rubber Keypad

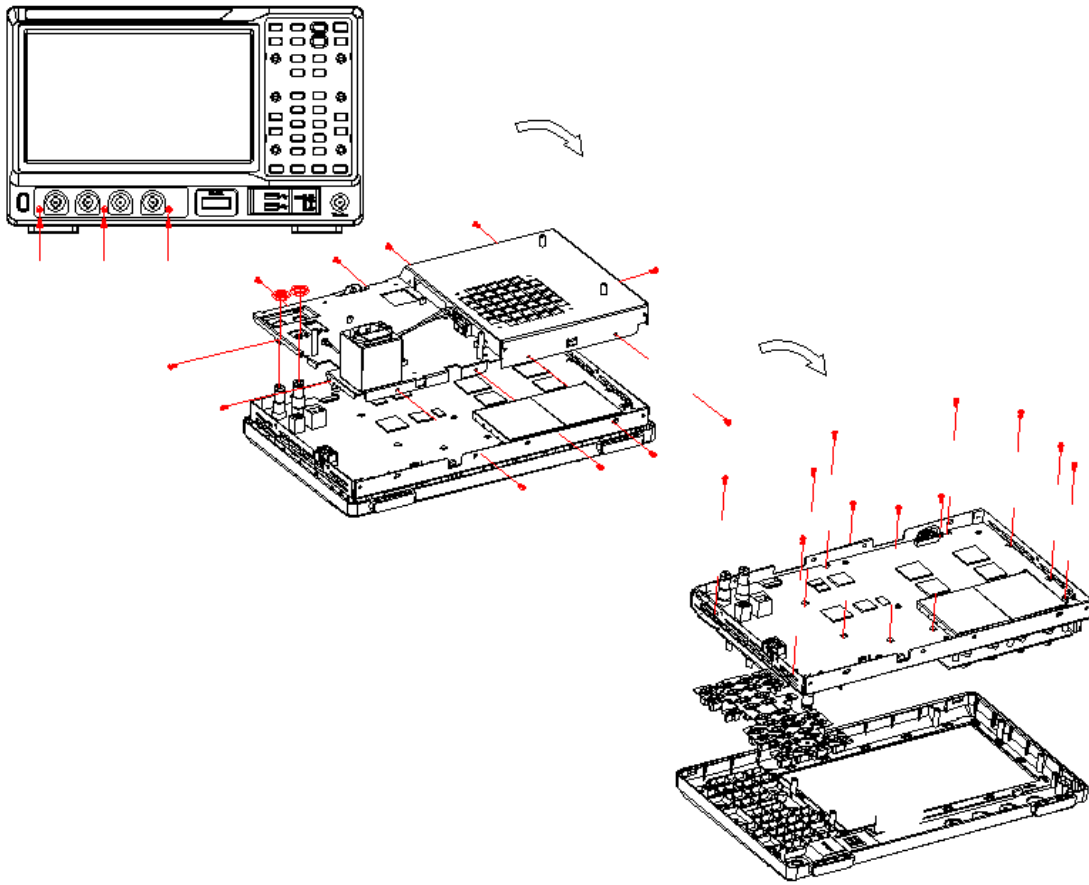

Figure 15 To remove the front panel and rubber keypad

#### Steps:

1. Remove the three PM3\*6 screws on the front of the panel.
2. Remove the eleven PM3\*6 screws outside the rear metal module.
3. Remove the two nuts on the rear BNC connectors.
4. Remove the rear metal module.
5. Remove the eleven PB3\*8 screws on the back of the panel.
6. Remove the front panel and rubber keypad.

### 6.3.4 To Remove the Keyboard and Probe Interface Board

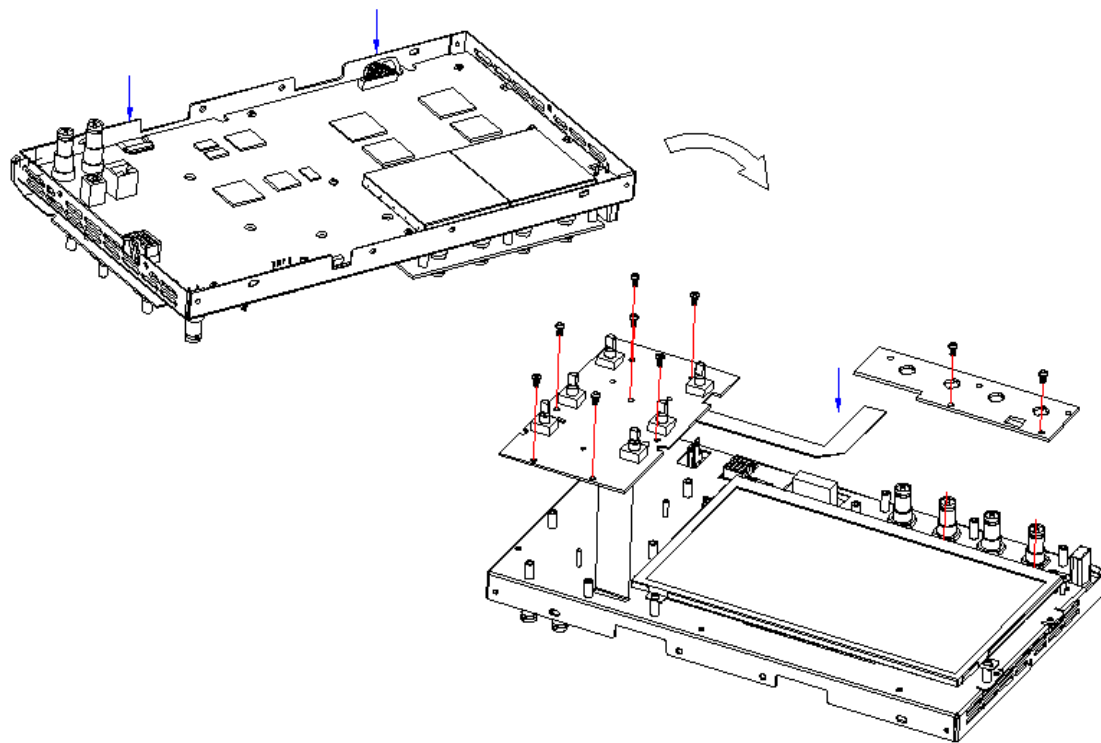

Figure 16 To remove the keyboard and probe interface board.

#### Steps:

1. Unplug the connecting cable from the mainboard.
2. Remove the two PM3\*6 screws on the probe interface board.
3. Disconnect the cable between the probe interface board and the keyboard.
4. Remove the Probe Interface Board.
5. Remove the seven PM3\*6 screws on the keyboard.
6. Remove the keyboard.

### 6.3.5 To Remove the Acquisition board

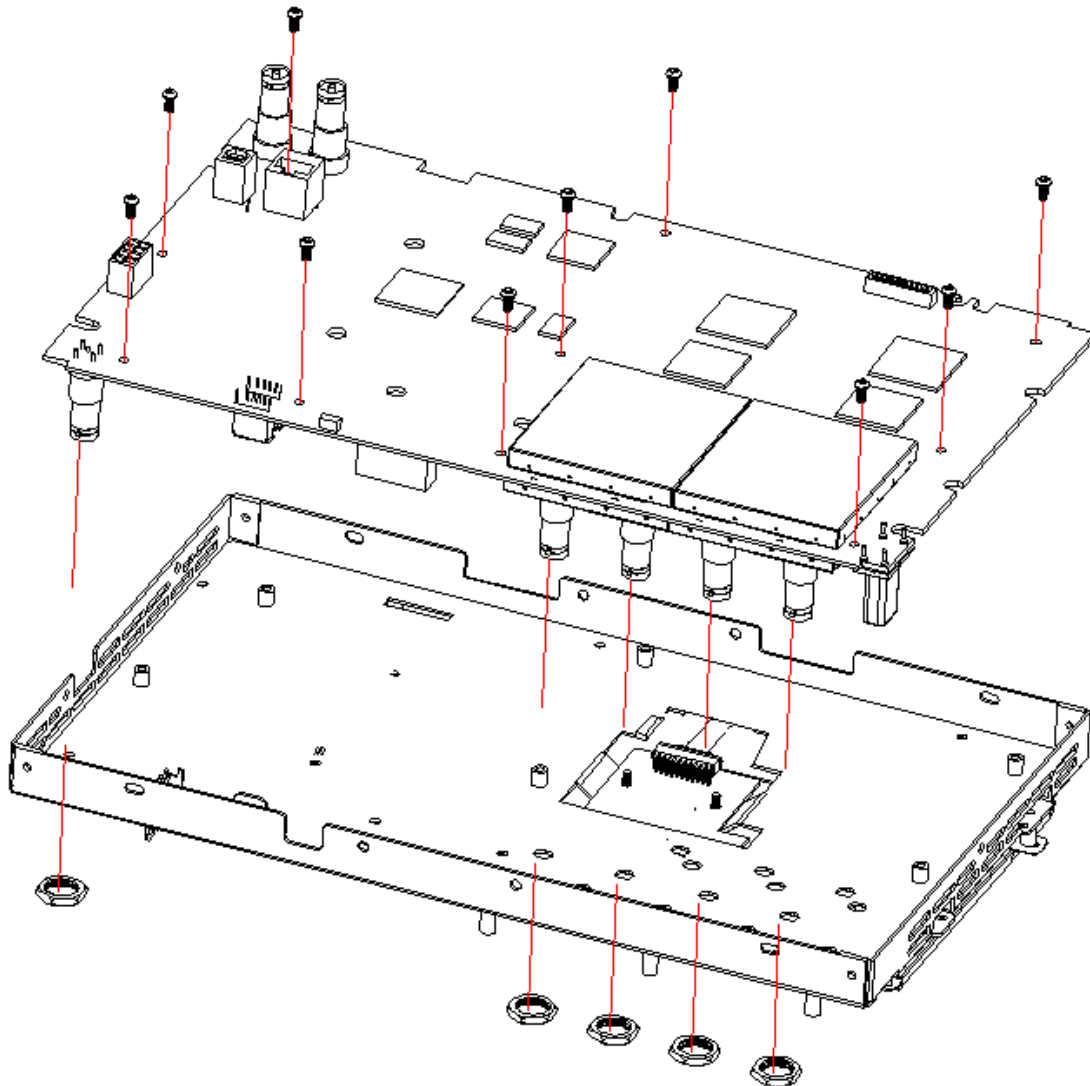

Figure 17 To remove the acquisition board

#### Steps:

1. Remove the five BNC nuts and gaskets on the front side of the metal frame.
2. Remove the ten PM3\*6 screws on the acquisition board.
3. Remove the Acquisition board.

### 6.3.6 To Remove the LCD Module and LCD Interface Board

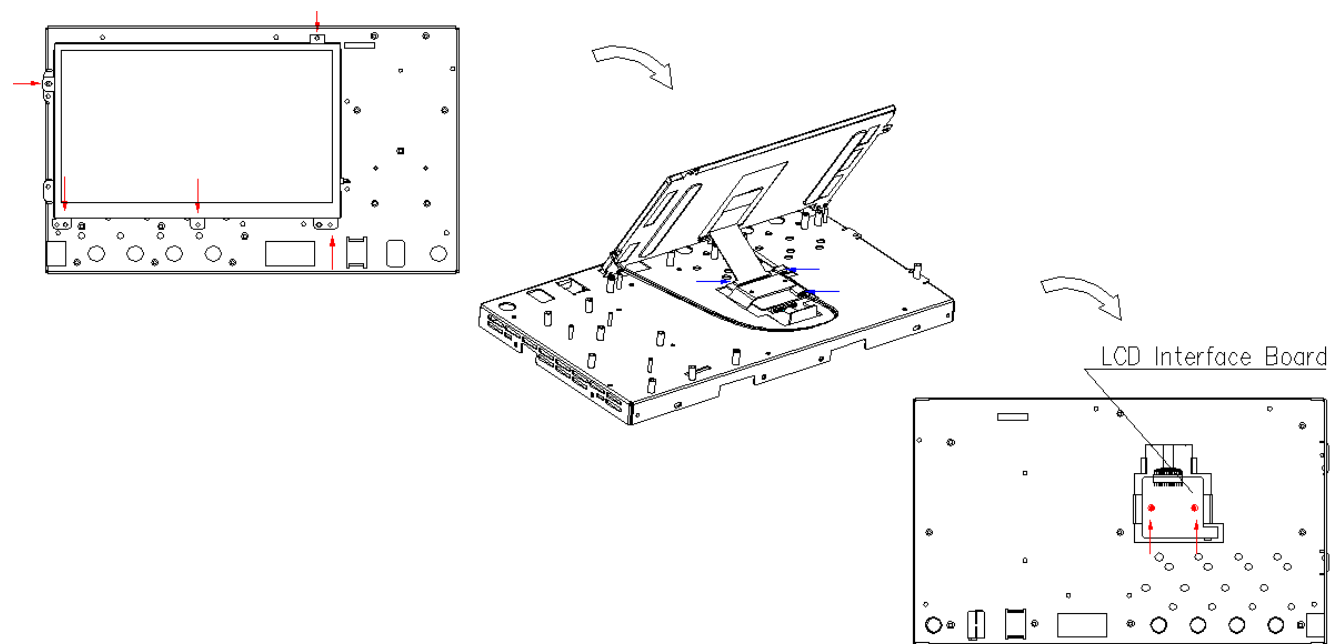

Figure 18 To remove the LCD module and LCD interface board

#### Steps:

1. Remove the five PM3\*6 screws on the LCD module.
2. Disconnect the cable between the LCD and LCD interface board.
3. Remove the LCD module.
4. Remove the two PM3\*6 screws on the LCD interface board.
5. Remove the LCD Interface board.



## 7 Solving General Problems

This chapter includes suggestions for solving general problems.

### If there is no display

Is the light of the power button glowing?

If yes:

- Go to the **Troubleshooting** chapter and check the power supply modules and acquisition board.

If no:

- Check that the power cord is secured in the power receptacle.
- Check that the fuse in the power receptacle is not blown out.
- Check that the power source is alive.
- If there is still no light glowing, go to the **Troubleshooting** chapter and check the power supply modules and acquisition board.

### If the display is stuck at the logo screen

- Remove all the USB devices plugged into the oscilloscope and power cycle the oscilloscope to try again.
- If not working, try to power cycle the oscilloscope and press the **math** button on the front panel multiple times when the scope is booting up.
- If not working, wait ten minutes to see if the oscilloscope can boot successfully. If not, contact SIGLENT for further instructions. If it is, try to upgrade to the latest firmware to solve the problem.
- If the display is still stuck at the logo screen, contact SIGLENT for further instructions.

### If there is no trace display

- Check the **Trace** option of the associated channel is **Visible**, not **Hidden**.
- Check the acquisition is running and trigger status is **Trig'd** or **Auto**.
- Check the horizontal time/division setting is reasonable and the acquisition time is short enough for fast display.
- Disconnect associated channel input and recall the default setup following the procedures in the User Manual.
- Turn on the associated channel again and press the Auto Setup key.
- If there is still no trace displayed, contact SIGLENT for further instructions.

#### **If the baseline trace drift out of specification**

- Check that the fan is running.
- Check that the vertical position setting is working.
- Perform self-calibration following the procedures in the User Manual.
- If self-calibration does not work, contact SIGLENT for further instructions.

#### **If there is an unexpected trace when no input connected to channel input**

- Power cycle the oscilloscope.
- Upgrade to the latest firmware.
- Contact SIGLENT for further instructions.

## 8 Troubleshooting

This chapter contains information and procedures for troubleshooting general hardware failures.

### 8.1 Safety Consideration and Cautions

Only qualified personnel should perform troubleshooting procedures. Disconnect the power cord whenever possible. DO NOT try to troubleshoot if visible damage is detected on the power supply module and the acquisition board, return it to SIGLENT for further repair.

**WARNING****HAZARDOUS VOLTAGES**

In case maintenance is performed with power supply on and without protective covers. Only qualified personnel with proper tools and protection should perform the maintenance. The equipment must be well-grounded during operation.

**WARNING****AVOIDELECTRICALSHOCK**

Hazardous voltages exist on the power supply and LCD modules. To avoid electrical shock, disconnect the power cord and wait at least three minutes for the capacitors to discharge before you begin disassembly.

**CAUTION****ESD CAUTION**

Electrostatic discharge (ESD) sensitive devices inside. Electronic components may be damaged without protection. Proper ESD precautions should be taken to avoid performance degeneration or loss of functionality. As a minimum, place the oscilloscope on a properly grounded ESD mat and wear a properly grounded ESD strap.

**CAUTION****REMOVE POWER SUPPLY TO AVOID DAMAGE**

Remove the power supply before you start to disassemble or replace parts. Disassembling or replacing parts with power on is not allowed. Damage to the components may occur.

**CAUTION****USE AN EXTERNAL FAN**

When you remove the oscilloscope metal cover, always use an external fan to provide airflow over the heat sinks and the acquisition board.

## 8.2 Required Equipment

Table 13 Required Equipment

Equipment	Critical Specifications	Recommended Model
Digital Multi-meter	Accuracy $\pm 0.05\%$ 1 mV resolution	SIGLENT SDM3065X Agilent 34401A
Oscilloscope	200 MHz BW 1 M $\Omega$ impedance	SIGLENT SDS1204X-E

## 8.3 Troubleshooting Flowchart

The following flowchart describes how to troubleshoot the oscilloscope in the most general case. This does not guarantee a 100% recovery of all possible hardware failures. Contact SIGLENT if you cannot solve the problem.

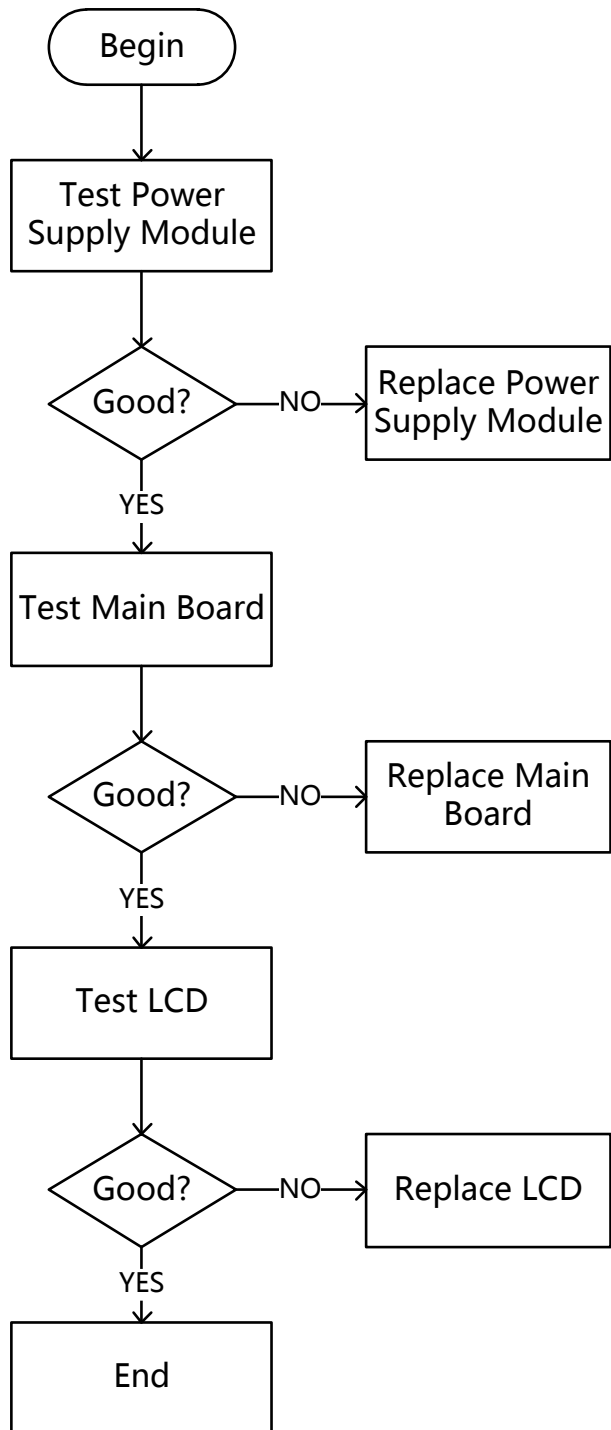

## 8.4 To Check the Power Supply Module

- Disconnect all the external cables and devices from the front and back panel.
- Disconnect the power cord of the oscilloscope.
- Remove the rear plastic cover and metal cover following the instructions in chapter **Disassembly Procedures**. Note that the power supply module is on the metal frame and you do not have to remove the power supply module to check it.
- Disconnect power supply cable from the acquisition board.
- Reconnect the power cord to the receptacle of the power supply module. Be cautious when working near the power supply module without the protective cover, high voltage may exist on the heat sink and other exposed conductor.
- Test the power supply with a multi-meter.

Table 14 Pin assignments of connectors on board

Connector	Pin Number	Wire Color	Specification
Power Supply	1, 2	Red	6.2 ~ 6.8 VDC
	3	Orange	-8 ~ -10 VDC (Not used)
	4, 5, 6	Black	COM/GND
	7	Brown	Trigger Signal for AC Line
	8	Blue	14 ~ 16 VDC

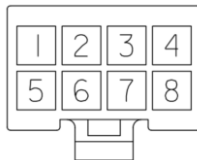
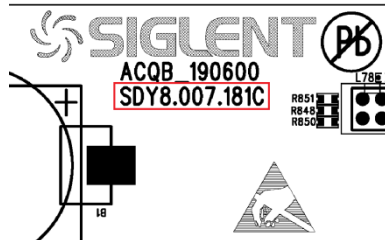

Figure 19 Pin definition of the power supply connector

## 8.5 To Check the Acquisition Board

This guide is based on the acquisition board revision C (labeled SDY8.007.181C). Future revision will be compatible unless described differently.



### 8.5.1 Acquisition Board SDY8.007.181C

#### 8.5.1.1 Acquisition Board Drawing

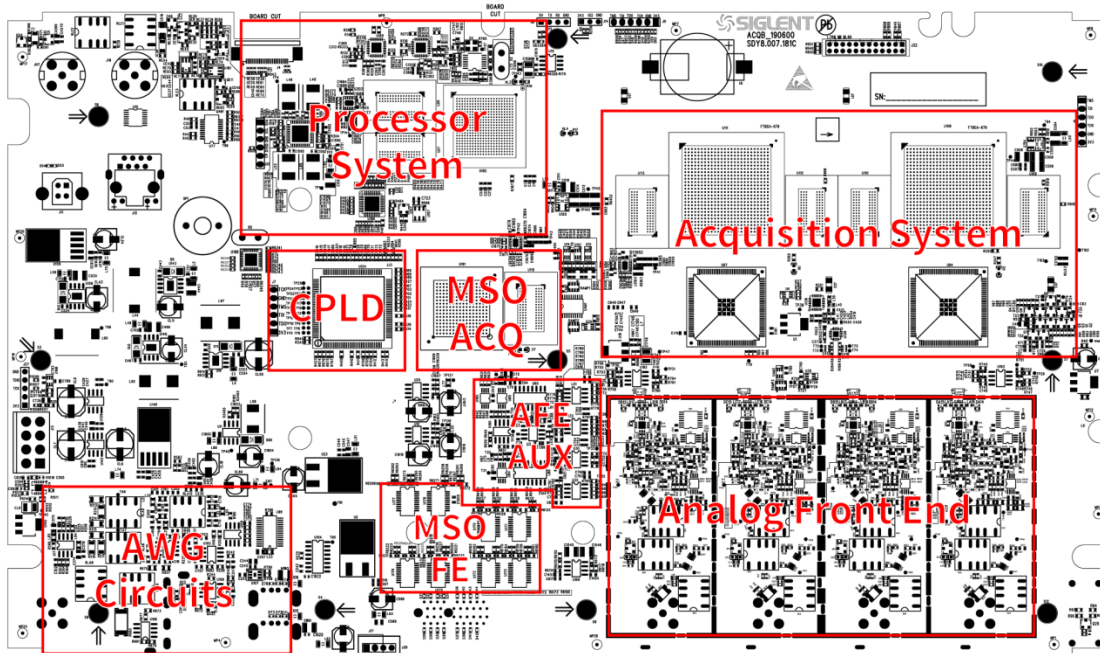

- Most of the test points are located on the top side of the board, it is not necessary to completely remove the board from the chassis to do the troubleshooting unless noticed. It is recommended to re-assemble the power supply module to the metal frame for safety considerations. Follow the instructions in chapter **Disassembly Procedures**.
- Reconnect the power cable to the acquisition board after you have

confirmed that the power supply module is in good condition.

- Power up the acquisition board by pushing the front panel power button.
- In most cases, you can hear the relays click if the acquisition board power up successfully. If you cannot hear the click or there is no sign that the acquisition board is powering up, go to **To Check the Power Supply Module** section to check the stand-by power and the main power.
- If the power or the signal under test is abnormal, replace the acquisition board.

### 8.5.1.2 Check the board-level power supplies

Check the board-level power supplies. Find and measure those test points using a multi-meter.

Table 15 Voltage parameters of the board level power supplies

Number	Test Points	Net Name	Specification
1	TP142	VCC3V3_PWR	$3.3V_{DC} \pm 0.2V_{DC}$
2	T90	VCC15V	$15V_{DC} \pm 1V_{DC}$
3	C439	VCC6V5	$6.5V_{DC} \pm 0.3V_{DC}$
4	TP1	VCC1V0_ZYNQ	$1V_{DC} \pm 50mV_{DC}$
5	TP2	VCC1V8_ZYNQ	$1.8V_{DC} \pm 90mV_{DC}$
6	TP3	VCC1V5_ZYNQ	$1.5V_{DC} \pm 75mV_{DC}$
7	TP4	VCC3V3_ZYNQ	$3.3V_{DC} \pm 0.2V_{DC}$
8	TP143	VCC2V5_ZYNQ	$2.5V_{DC} \pm 0.1V_{DC}$
9	T86	DVCC3V3	$3.3V_{DC} \pm 0.2V_{DC}$
10	T93	DVCC1V2	$1.2V_{DC} \pm 80mV_{DC}$
11	T94	DVCC1V5_ACQ1	$1.5V_{DC} \pm 75mV_{DC}$
12	TP140	DVCC1V5_ACQ2	$1.5V_{DC} \pm 75mV_{DC}$
13	T97	AVCC5V	$5V_{DC} \pm 0.1V_{DC}$



14	T95	AVCC5V_AWG	$5V_{DC} \pm 0.1V_{DC}$
15	T101	AVEE-5V	$-5V_{DC} \pm 0.1V_{DC}$
16	TP39	VCC3V3_PLL	$3.3V_{DC} \pm 0.2V_{DC}$
17	TP47	VCC3V3_CH	$3.3V_{DC} \pm 0.2V_{DC}$
18	T99	AVCC1V9	$1.9V_{DC} \pm 80mV_{DC}$
19	T111	VCC5V_VBUS	$5V_{DC} \pm 0.25V_{DC}$
20	TP136	VCC12V5	$12.5V_{DC} \pm 0.1V_{DC}$
21	TP137	VCC12V	$12V_{DC} \pm 0.1V_{DC}$
22	TP138	VCC8V	$8V_{DC} \pm 0.1V_{DC}$

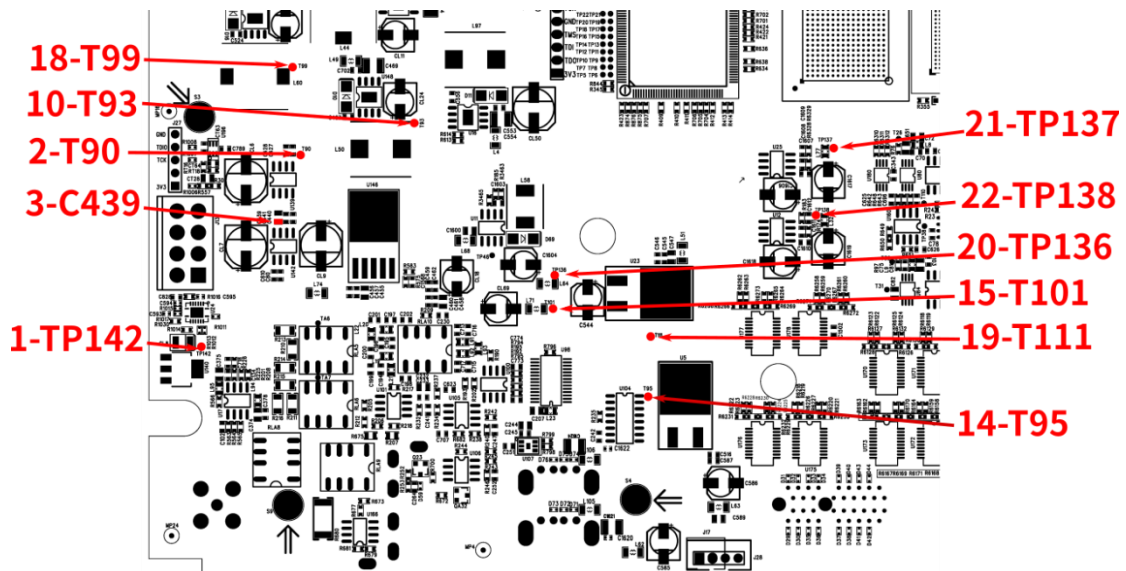

Figure 20 Test points for the Acquisition board power supplies

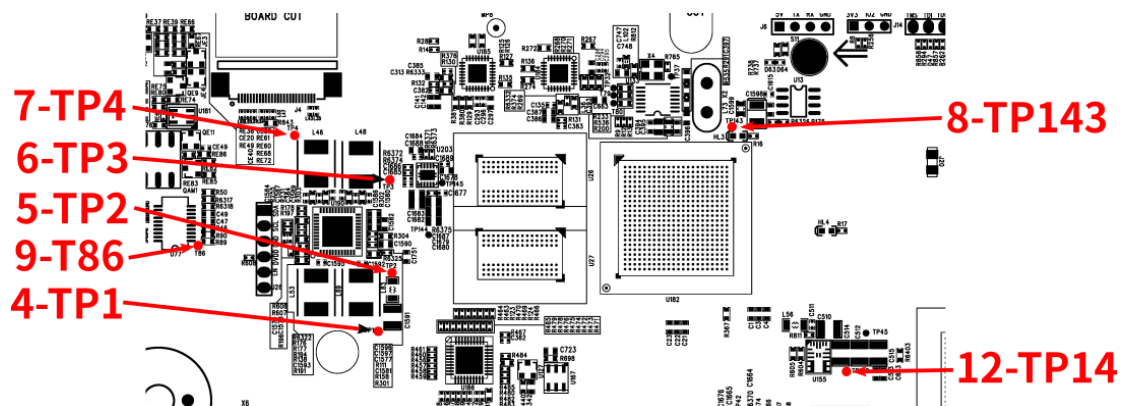

Figure 21 Test points for the Acquisition board power supplies (continued)

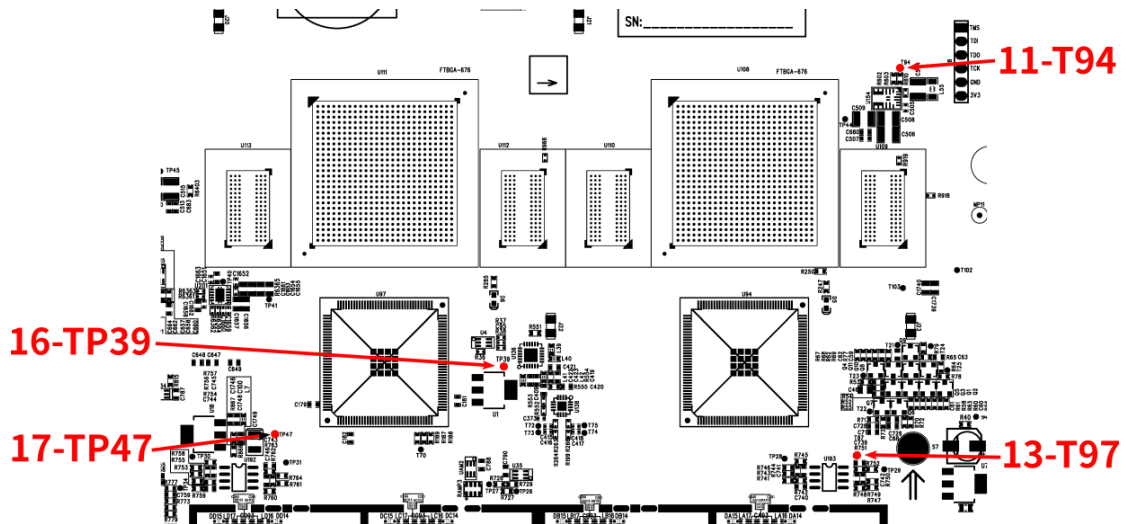

Figure 22 Test points for the Acquisition board power supplies (continued)

### 8.5.1.3 Check the clock

There are 4 clock oscillators and associated fanout buffers on board to source different circuitries. Each of them serves one or more function. The voltage compliance of all the clock under test is LVCMOS33.

Table 16 Clock parameters of the Acquisition System

Clock Frequency	Test Point	Served Function
12MHz ±50ppm	T79	ACQ Asynchronous Clock
	T80	Reference Clock for USB Device
	TP32	Reference Clock for USB Host
25MHz ±25ppm	R545	Reference Clock for PL
	R546	Reference Clock for Ethernet
	R547	Reference Clock for CPLD
	R548	Reference Clock for ACQ1
	R549	Reference Clock for ACQ2
	R550	Reference Clock for MSO
33.3333MHz ±25ppm	TP37	Reference Clock for CPU
10MHz ±5ppm	R37	Reference Clock for PLL Tolerance maybe larger if the software is malfunction.

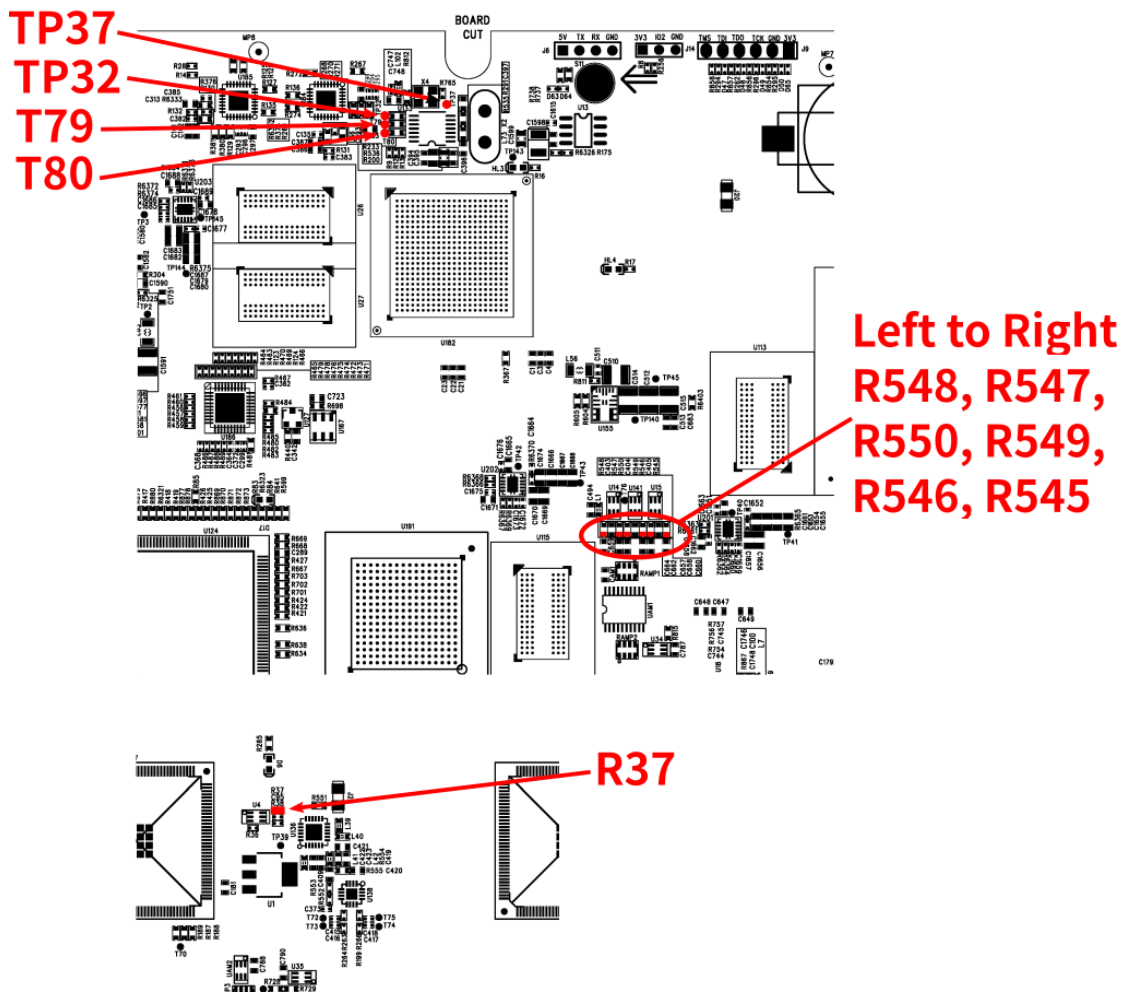

Figure 23 Test points for clock

## 8.6 To Check the LCD

- Reconnect the power cable to the acquisition board after you have confirmed that the power supply module is in good condition.
- Connect the LCD cable to the acquisition board.
- Power up the acquisition board by pushing the front panel power button.

### 8.6.1 To Check the LCD Power Supply

Find connector J32 and measure those test points using a multi-meter.

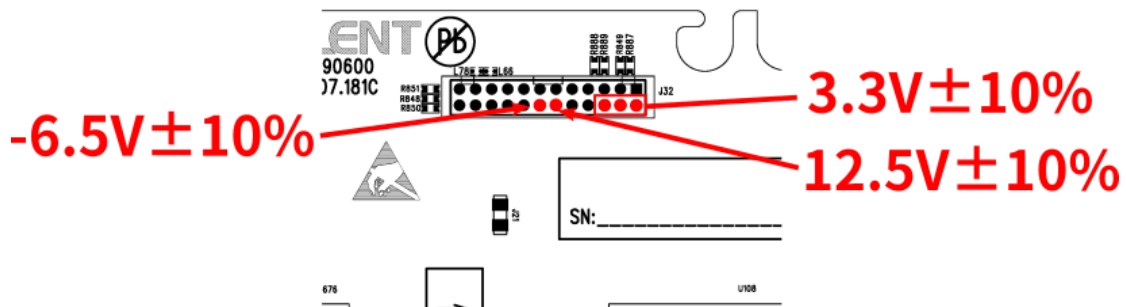

Figure 24 Test points for the LCD power supplies

If the power supply is out-of-specification, double-check with LCD cable disconnected. If the power supply is still out-of-specification, replace the acquisition board. If the power supply is good when the LCD cable is disconnected, replace the LCD panel or the LCDI board (the board between the acquisition board and the LCD panel).

### 8.6.2 To Check the LCD Signal

Find connector J32, use an oscilloscope to measure the signal using the method below. Be aware that a 200 MHz oscilloscope may not be suitable for signal quality check, but good enough for signal presence detection.

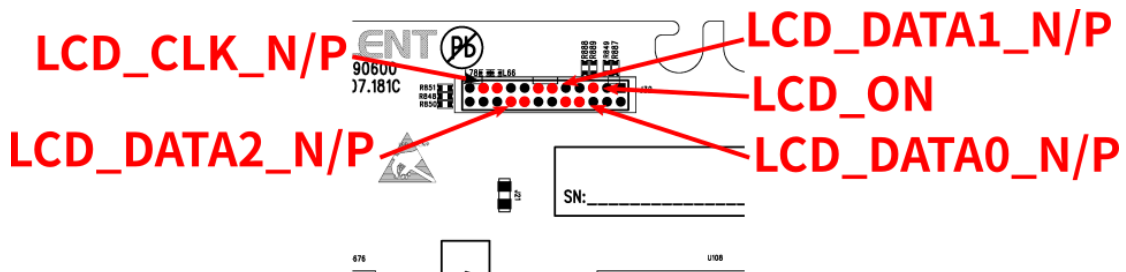

Figure 25 Test points for LCD signal

Table 17 Signal parameters of the LCD

Test Point	Signal	Compliance	Description
J32 PIN5	LCD_ON	LVC MOS33	PWM signal to control the brightness of the LCD. Normally HIGH.
J32 PIN8/10	LCD_DATA0_N/P	LVDS	LCD DATA signal. Always active.
J32 PIN11/13	LCD_DATA1_N/P	LVDS	LCD DATA signal. Always active

---

J32 PIN16/18	LCD_DATA2_N/P	LVDS	LCD DATA signal. Always active
J32 PIN19/21	LCD_CLK_N/P	LVDS	LCD reference clock, typically 50MHz

---

- If the signal is active, replace the LCD panel.
- If the signal is stuck, double-check with LCD cable disconnected. If the signal still stuck, replace the acquisition board. If not, replace the LCD panel or the LCDI board.

## About SIGLENT

SIGLENT is an international high-tech company, concentrating on R&D, sales, production and services of electronic test & measurement instruments.

SIGLENT first began developing digital oscilloscopes independently in 2002. After more than a decade of continuous development, SIGLENT has extended its product line to include digital oscilloscopes, function/arbitrary waveform generators, RF generators, digital multimeters, DC power supplies, spectrum analyzers, vector network analyzers, isolated handheld oscilloscopes, electronic load and other general purpose test instrumentation. Since its first oscilloscope, the ADS7000 series, was launched in 2005, SIGLENT has become the fastest growing manufacturer of digital oscilloscopes. We firmly believe that today SIGLENT is the best value in electronic test & measurement.

### Headquarters:

SIGLENT Technologies Co., Ltd  
Add: Bldg No.4 & No.5, Antongda Industrial  
Zone, 3rd Liuxian Road, Bao'an District,  
Shenzhen, 518101, China  
Tel: + 86 755 3688 7876  
Fax: + 86 755 3359 1582  
Email: sales@siglent.com  
Website: int.siglent.com

### USA:

SIGLENT Technologies America, Inc  
6557 Cochran Rd Solon, Ohio 44139  
Tel: 440-398-5800  
Toll Free: 877-515-5551  
Fax: 440-399-1211  
Email: info@siglent.com  
Website: www.siglentna.com

### Europe:

SIGLENT Technologies Germany GmbH  
Add: Staetzlinger Str. 70  
86165 Augsburg, Germany  
Tel: +49(0)-821-666 0 111 0  
Fax: +49(0)-821-666 0 111 22  
Email: info-eu@siglent.com  
Website: www.siglenteu.com

Follow us on  
Facebook: SiglentTech

